

NEWTON, PRINCIPIA, 1687



BERNARDO TRIVISANO  
1718

# EC8-5:2022 GEOTECHNICS



**ETHZ CENTRIFUGE KRUPP REFUBISHED 8.25 M 2 T**

Conventional Design

$$M_{ult} > M_{RD}$$

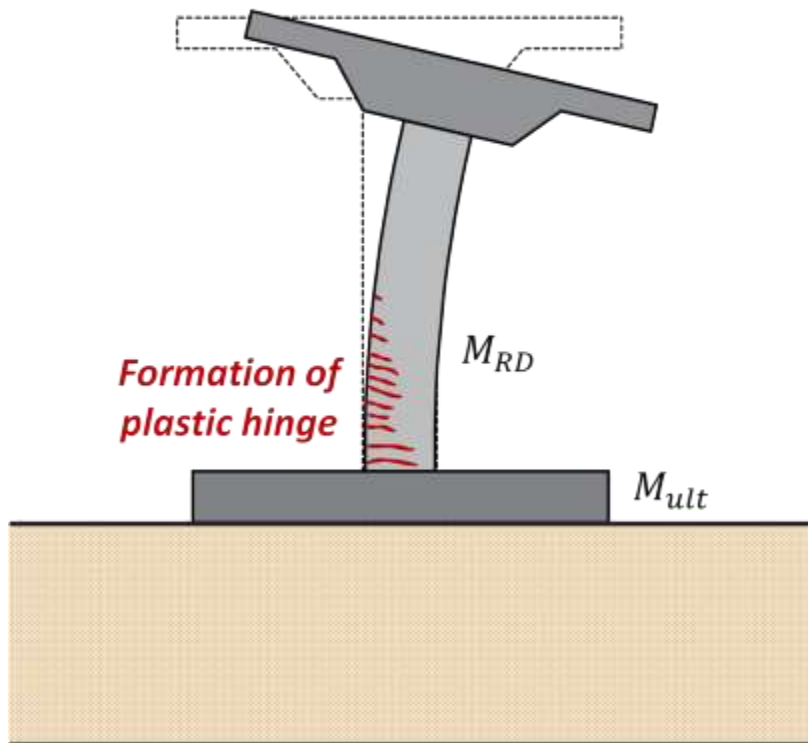

Rocking Isolation

$$M_{ult} < M_{RD}$$

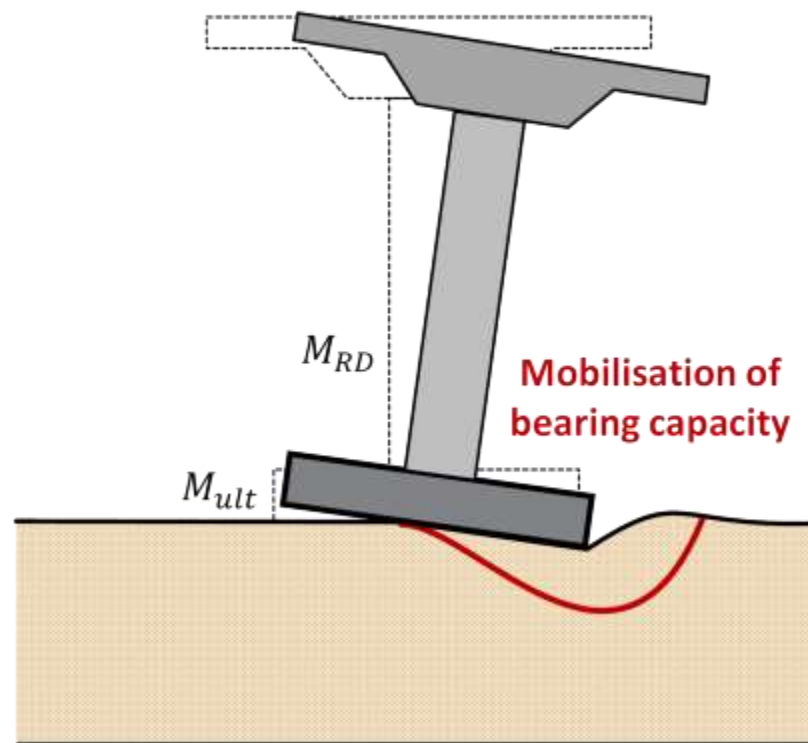



Conventional design vs. Rocking isolation (Rankine Lecture by Prof. George ...



Copia link



Stiffer soil: elastic foundation response  
*pancake collapse*



Poor soil conditions: accidental rocking isolation  
*settlement* *rotation*



# Example: new definition of elastic spectrum

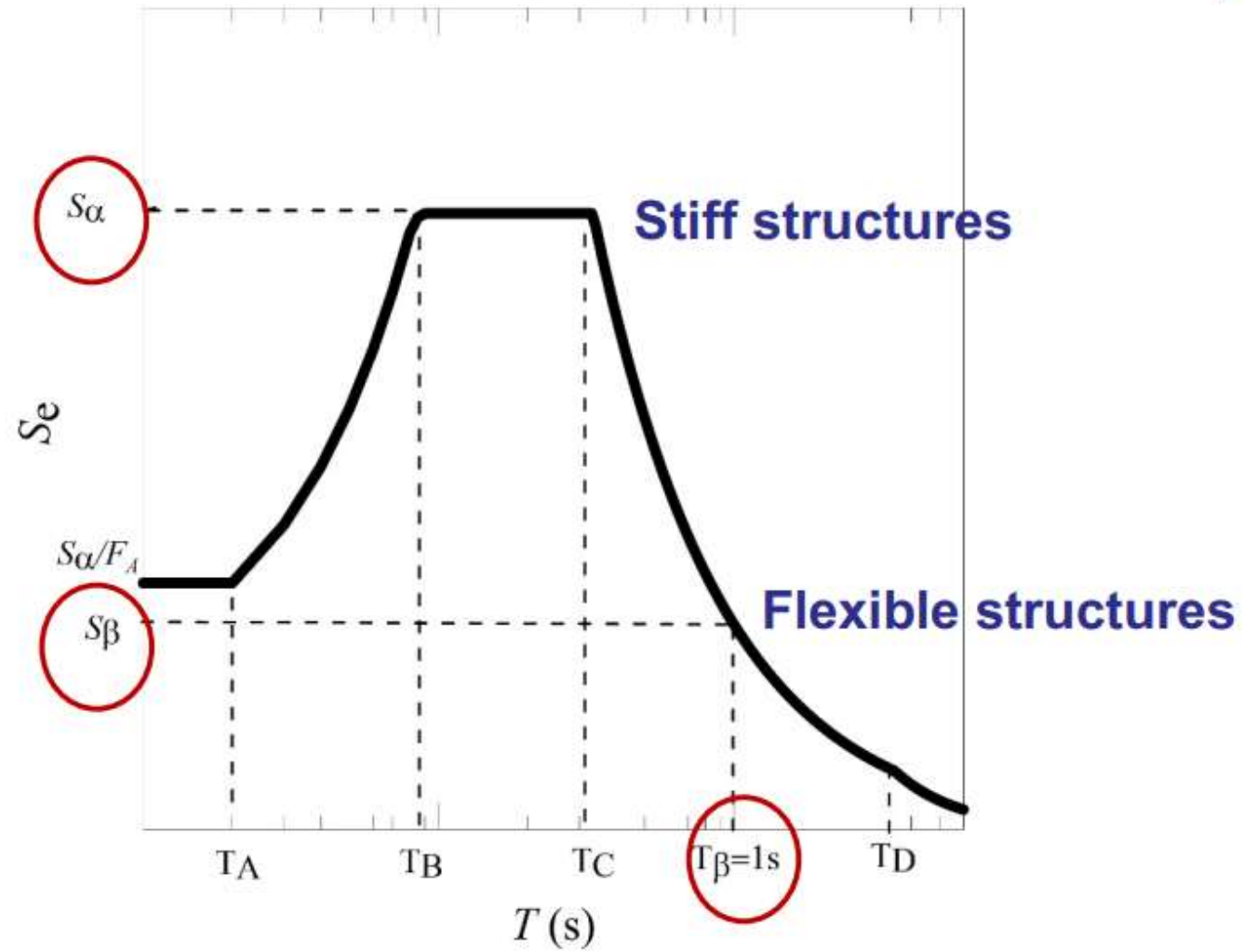



→ *2nd Generation Eurocode (4 parts)*

1. EN1990 – Basis of design – also geotechnical rules!
2. EC7 Part 1 – General rules for all structures, safety, characteristic values
3. EC7 Part 2 – Geotechnical Parameters and how to derive them from tests
4. EC7 Part 3 – Rules for specific geotechnical structures, many calculation models in Annex

# ANASTASOPOULOS, KASSAS SHALLOW STRIP FOUNDATION LIQUEFACTION

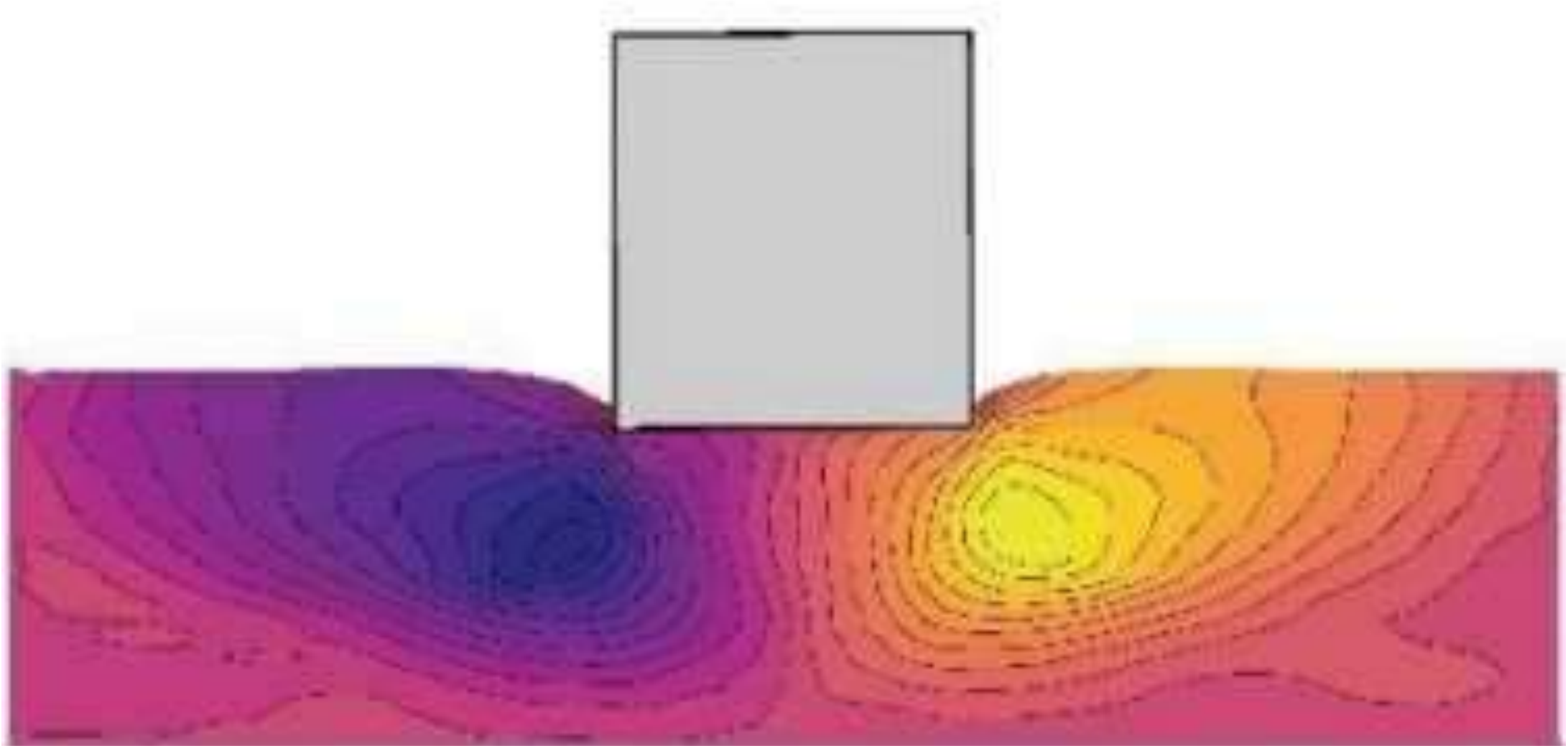



# EC8 EN1998 DESIGN OF STRUCTURE FOR EARTHQUAKE RESISTANCE

PHILIPPE BISCH, ALAIN PECKER

## PARTS

EC8-1	1-1	GENERAL RULES AND SEISMIC ACTION	PIERRE LABBE'
	1-2	BUILDINGS	ANDRE PLUMIER
EC8-2		BRIDGES	FRANCHIN, KAPPOS
EC8-3		ASSESSMENT AND RETROFITTING OF BUILDINGS AND BRIDGES	ANDREAS KAPPOS
EC8-4		SILOS, TANKS, PIPELINES, TOWERS, MASTS, CHIMNEYS	BUTENWEG
EC8-5		GEOTECHNICS: GENERAL RULES AND SEISMIC ACTION	ALAIN PECKER

# EC8-5 GEOTECHNICS: GENERAL RULES AND SEISMIC ACTION

- 5-1 BASIS OF DESIGN ALAIN PECKER
- 5-2 SOIL STABILITY, LIQUEFACTION AMIR KAYNIA
- 5-3 SOIL STRUCTURE INTERACTION GEORGE GAZETAS
- 5-4 SHALLOW FOUNDATION, PILES ANTONIO CORREIA
- 5-5 RETAINING STRUCTURE LUIGI CALLISTO
- 5-6 UNDERGROUND STRUCTURES KYRIAZIS PITILAKIS

# EC8-5-GEOTECHNICS

- Chapter 4 : Basis of design
- Chapter 5 : Seismic action
- Chapter 6 : Ground properties
- Chapter 7 : Requirements for siting and foundation soils
- Chapter 8 : Soil structure interaction **SSI**
- Chapter 9 : Foundation systems
- Chapter 10 : Earth retaining structures
- Chapter 11 : Underground structures

## EC8-5 ANNEXES

- Annex A: Reduction of the seismic action as an effect of wall height and predominant wavelength
- Annex B: Procedure for liquefaction analyses
- Annex C: Evaluation of soil settlements
- Annex D: Simplified evaluation of soil structure interaction effects
- Annex E: Impedance functions for surface and deep foundations
- Annex F: Seismic bearing capacity of shallow foundations
- Annex G: Evaluation of earth pressures on retaining structures
- Annex H: Simplified evaluation of peak ground parameters for seismic design of underground structures
- Annex I: Simplified analytical expressions for the seismic design of tunnels
- Annex J: Impedances functions for underground structures

## EC8-5-4 BASIS OF DESIGN

- Peculiar aspect : Part 5 has to deal with
  - Geotechnical structures
    - structure that includes ground or a structural member that relies on the ground for resistance; e.g. retaining walls , slope, dike.
  - Geotechnical systems
    - complex systems where one geotechnical structure interacts with other structures or geotechnical structures; e.g. retaining walls with a supported structure at the crest, slopes with a structure at the crest or toe.

# IMPLICATIONS

## GEOTECHNICAL STRUCTURES

- Performance requirements
  - Defined in EN 1998-5
- Consequence classes / Return Period
  - Three classes CC1, CC2 and CC3 (NDP)

Limit State	Consequence class		
	CC1	CC2	CC3
NC	800	1600	2500
SD	250	475	800
DL	50	60	60

## GEOTECHNICAL SYSTEMS

- Performance requirements
  - Defined in EN 1998-1-1 according to LS
- Consequences classes / Return Period
  - Those of the structure

## EC8-5-4 SEISMIC ACTION CLASSES

- Defined in EN 1998-1-1

$$S_{\delta} = \delta F_{\alpha} F_T S_{\alpha,475}$$

- Used to **classify** the seismic action

Seismic action class	Range of seismic action index
Very low	$S_{\delta} < 1,30 \text{ m/s}^2$
Low	$1,30 \text{ m/s}^2 \leq S_{\delta} < 3,25 \text{ m/s}^2$
Moderate	$3,25 \text{ m/s}^2 \leq S_{\delta} < 6,50 \text{ m/s}^2$
High	$S_{\delta} \geq 6,50 \text{ m/s}^2$

- Methods of analyses and performance requirements in EN 1998-5 depend on **seismic action index**  $S_{\delta}$

## EC8-5-5 SEISMIC ACTION INDEX

$$S_{\delta} = \delta F_{\alpha} F_T S_{\alpha,475}$$

- $\delta$  : NDP

### GEOTECHNICAL STRUTURES

	Consequence class		
	CC1	CC2	CC3
$\delta$	0,6	1,0	1,5

### GEOTECHNICAL SYSTEMS

- Values of  $\delta$  are equal to those of the structure (see relevant parts of EC8)



# METHODS OF ANALYSES

- Force-based approach (FBA)
  - Compliance checked in terms of generalised stresses
- Displacement-based approach (DBA)
  - Compliance checked by comparison of permanent displacements to acceptable ones

$$E_{Fd} \leq R_d$$

Design value of action

- FBA: generalised stresses
- DBA: calculated displacements

Design value of

- FBA: resistance
- DBA: allowable displacements

# DESIGN VALUE OF RESISTANCE $R_d$

- **Material factor approach (MFA):** preferred choice in EN 1998-5
  - Allowed for displacement-based or force-based approaches

$$R_d = R \left\{ \frac{X_k}{\gamma_m}; a_d; \sum F_{Ed} \right\}$$

- **Resistance factor approach (RFA)**
  - Allowed only for force-based approaches

$$R_d = \frac{1}{\gamma_R} R \left\{ X_k; a_d; \sum F_{Ed} \right\}$$

- **Effect Factor Approach (EN 1997)**
  - Does not apply to seismic design situation

# DISPLACEMENT-BASED APPROACH

- Acceptable methods to calculate the induced **permanent** displacements include:
  - **Non-linear static** analyses
  - **Response history** analyses
- Response history analyses require the use of **accelerograms** obtained from **natural records** (selected as per EN 1998-1-1:2021, 5.2.3.1) or **site-specific response** analyses
- Although EN 1998-1-1 allows artificial or spectrally matched accelerograms, determination of **ground permanent deformations or displacements** are better estimated with **natural accelerograms recorded** in real earthquakes

# EC8-5-5 SEISMIC ACTION SPATIAL INCOHERENCE

- Stability of geotechnical structures/systems involves large volume of soils. Seismic action is not uniform throughout the volume

➤ Spatial incoherence, variation with depth.....

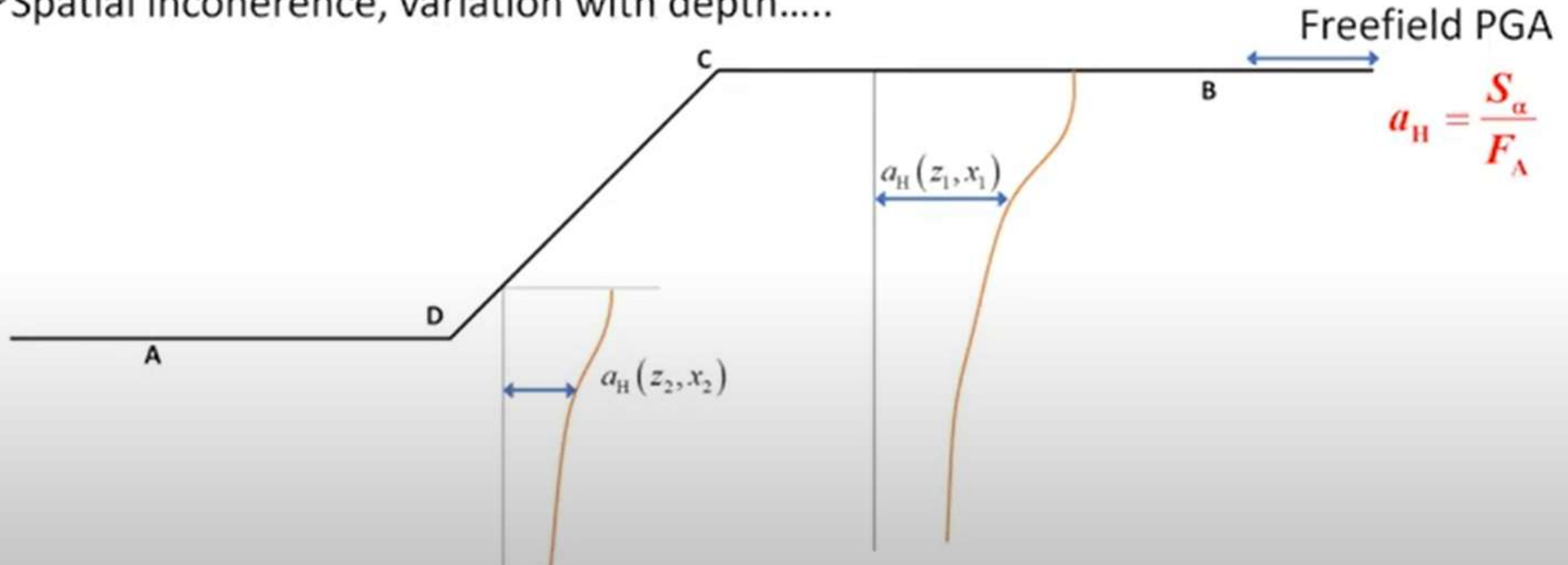

# SEISMIC ACTION

- Seismic action defined by a conventional horizontal ground acceleration  $a_H$

$$a_H = \frac{\beta_H}{\chi_H} \frac{S_\alpha}{F_A} = \frac{\beta_H}{\chi_H} PGA_e$$

- $PGA_e$  : design value of horizontal peak ground acceleration
- $\beta_H$  : coefficient reflecting the spatial variation with depth of the horizontal ground motion within the ground mass ( $0 \leq \beta_H \leq 1$ )
- Horizontal spatial variability of ground motion defined in EN 1998-1-1: 5.2.3.2

# SEISMIC ACTION : VARIABILITY WITH DEPTH

- Applicable to FBA or DBA
- Depends on model and method of analysis
- Can be computed from site response analysis
- Simplified evaluation is provided in Annex A

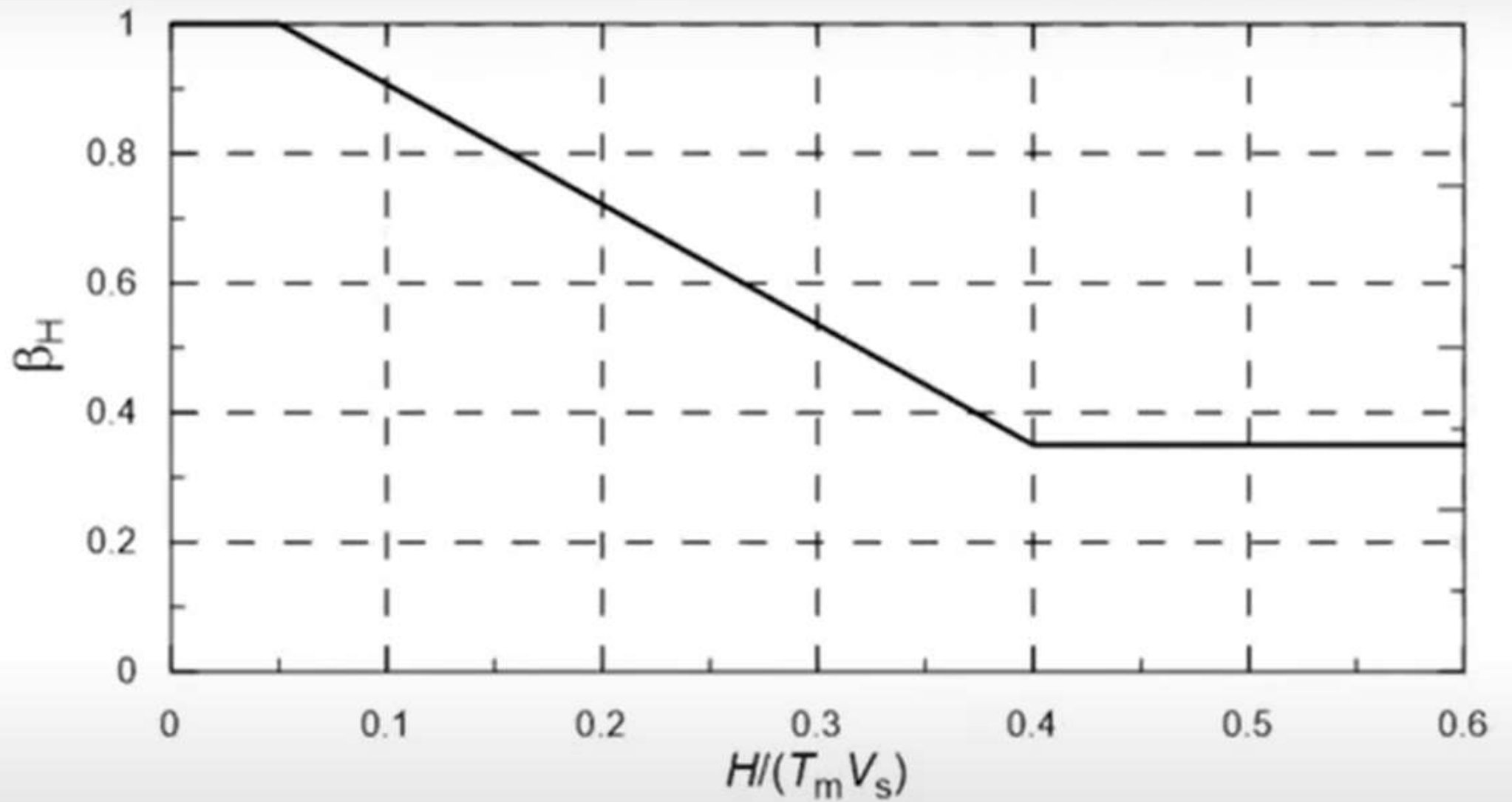

$H$  slope height or height of retaining structure in contact with the soil

$V_s$  shear wave velocity

$$T_m = (T_B + T_C)$$

# SEISMIC ACTION

$$a_H = \frac{\beta_H}{\chi_H} \frac{S_\alpha}{F_A} = \frac{\beta_H}{\chi_H} PGA_e$$

- $\chi_H$  : coefficient reflecting the amplitude of accepted **permanent displacements** of the soil-structure system induced by the horizontal ground motion for the considered consequence class and limit state
- $\chi_H$  : reflects the **nonlinear soil behaviour**; it depends on soil type and structure
- In DBA  $\chi_H$  shall be taken equal to 1,0.



# EN 1998-5-6 GROUND PROPERTIES

## DEFORMATION

- The profile of the **shear wave velocity**  $V_s$  in the ground should be regarded as the most reliable indicator of the stiffness of the ground layers for seismic design.
- **Direct measurement** of the  $V_s$  profile should be used for **moderate and high seismic action classes**
- For all **other cases**, the  $V_s$  profile may be estimated by **empirical correlations** with in-situ tests

Seismicity level	$150 \leq v_s < 250 \text{ m/s}$		$250 \leq v_s < 400 \text{ m/s}$		$400 \leq v_s < 800 \text{ m/s}$		$800 \text{ m/s} \leq v_s$	
	$G/G_0$	$\xi$	$G/G_0$	$\xi$	$G/G_0$	$\xi$	$G/G_0$	$\xi$
<b>Very low</b>	0,70 (±0,08)	0,04	0,80 (±0,09)	0,03	1,00	0,03	1,00	0,02
<b>Low</b>	0,50 (±0,14)	0,07	0,65 (±0,16)	0,05	0,80 (±0,10)	0,03	1,00	0,02
<b>Moderate</b>	0,30 (±0,10)	0,10	0,50 (±0,20)	0,07	0,70 (±0,10)	0,05	1,00	0,02
<b>High</b>	0,20 (±0,10)	0,20	0,40 (±0,20)	0,12	0,60 (±0,20)	0,10	0,90 (±0,10)	0,02

NOTE 1 The seismicity level is defined in Table 5.2 of prEN 1998-1-1:2021.

NOTE 2  $G_0$  is the best estimate value at small strains ( $< 10^{-5}$ ), see also prEN 1997-2:2021, 9.1.4 and Annex F.

# EC8-5-6 GROUND PROPERTIES

## STRENGTH

- Saturated soils should be considered to behave under **undrained conditions**
- Soil undrained behaviour may be studied in terms of **total stresses**, or in terms of **effective stresses** with due account of the pore water pressure
- In terms of **total stresses**
  - For fine-grained soils, the appropriate strength parameter should be the **undrained shear strength  $c_u$** ;  $c_u$  should consider cyclic degradation effects under long duration earthquake actions.
  - For coarse-grained soil, the appropriate strength parameter should be the cyclic undrained shear strength  $\tau_{cy,u}$

## EC8-5-6 GROUND PROPERTIES: PARTIAL FACTORS

- In MFA approach **partial factors**  $\gamma_M$  should be applied to the ground strength parameters
- In RFA approach **partial factors**  $\gamma_R$  should be applied to the resistance
- Partial factors are **NDP**
- **Important remark: values of  $\chi_H$  given in EN 1998-5 have been calibrated for the recommended partial factors**
  - If different values for  $\gamma_M$  are specified in National Annexes,  $\chi_H$  needs to be recalibrated

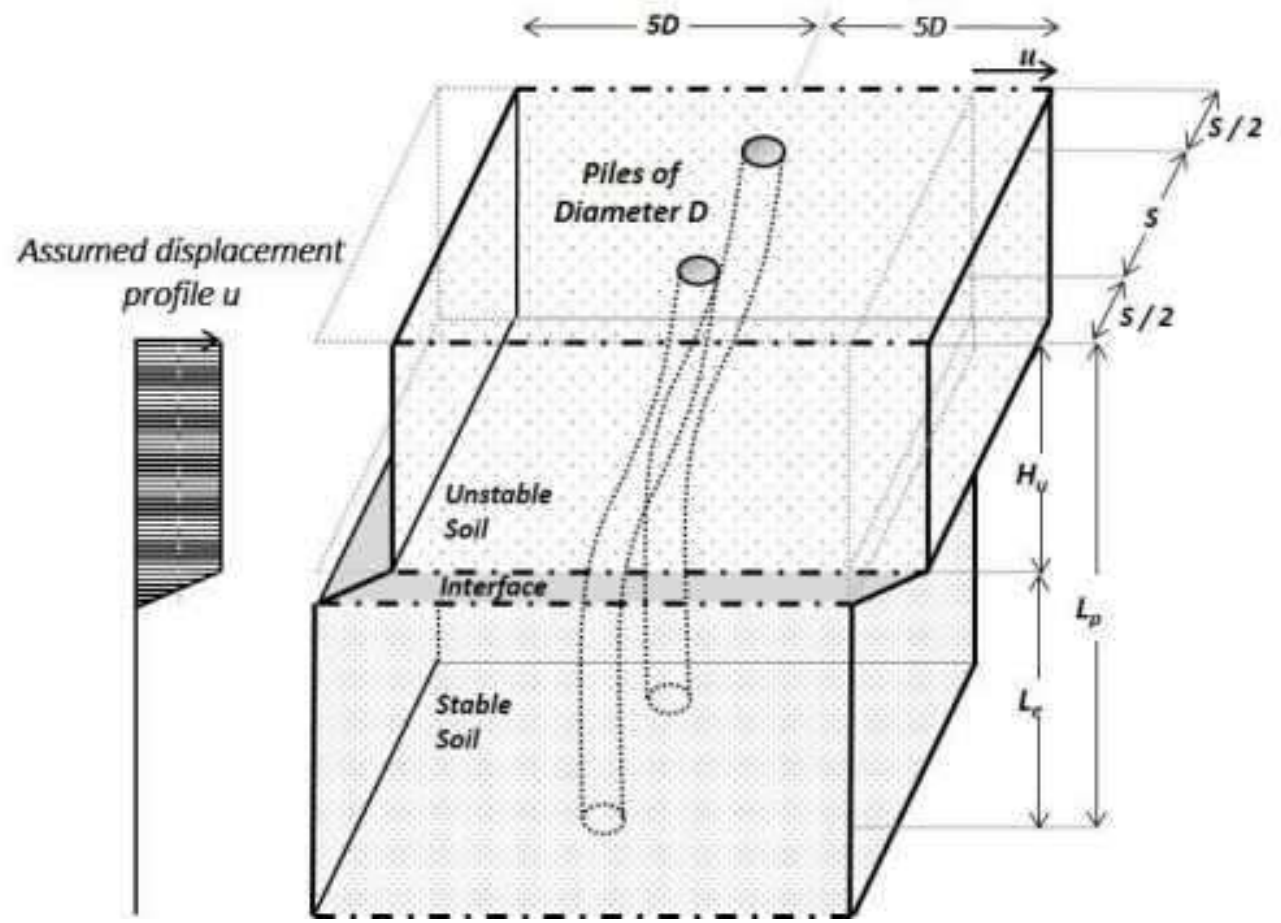
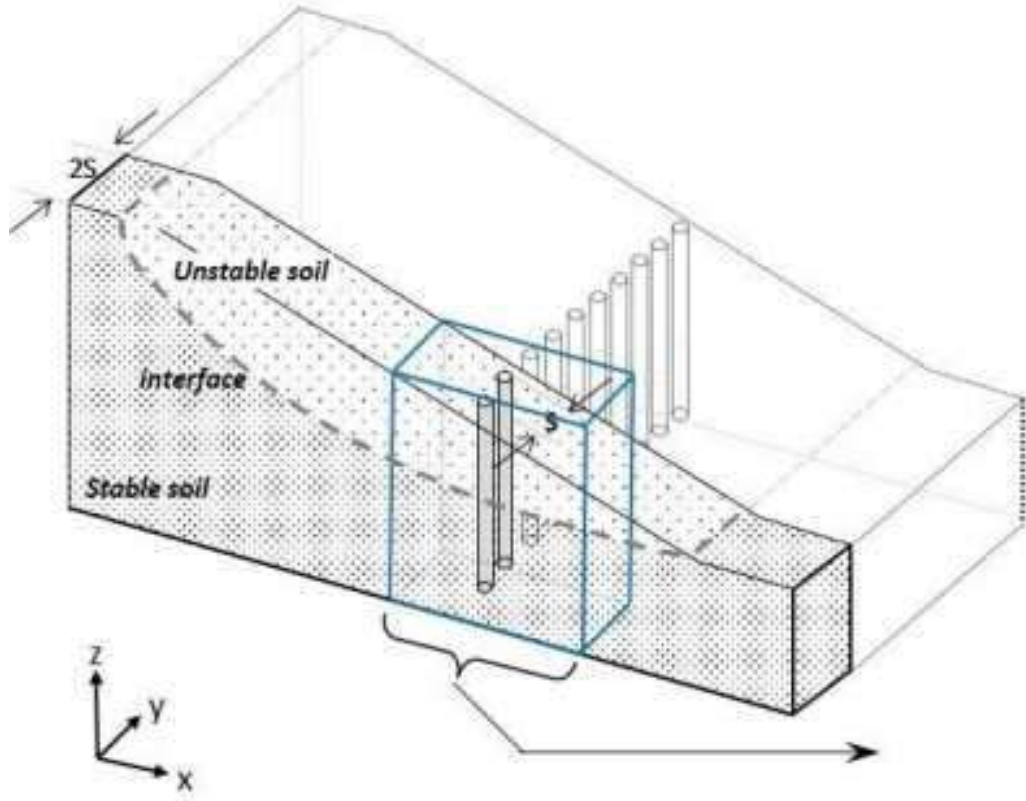

## EC8-5-6 RECOMMENDED PARTIAL FACTORS (NDP)

### RECOMMENDED PARTIAL FACTORS (NDP)

#### EN 1998-5:2021

- Undrained shear strength  $c_u$  : 1,0
- Drained cohesion  $c'$  : 1,0
- Drained friction angle ( $\tan \phi'$ ) : 1,0
- UC strength (rock): 1,0
- Undrained cyclic shear strength: 1,25
- Interface friction angle ( $\tan \delta_f$ ) : 1,0
- Global resistance factor (RFA) : 1,0

#### EN 1998-5:2004

- Undrained shear strength  $c_u$  : 1,4
- Drained cohesion  $c'$  : N/A
- Drained friction angle ( $\tan \phi'$ ) : 1,25
- UC strength (rock): 1,4
- Undrained cyclic shear strength: 1,25
- Interface friction angle ( $\tan \delta_f$ ) : N/A
- Global resistance factor (RFA) : N/A

# EC8-5-7 REQUIREMENTS FOR SITING AND FOUNDATION SOIL

## 7 Evaluation of the seismic response of the construction site

### Five topics are included

- Siting - Potentially active seismic faults
- Slope Stability
- Potentially liquefiable soil
- Settlements of soil under cyclic loading
- Ground response analysis (GRA)

### Two associated Annexes (informative)

- Annex B - Procedure for liquefaction analyses
- Annex C - Evaluation of settlements of coarse-grained soils

## 7.1 Siting

### 7.1.2 Potentially active seismic faults

- Close to potentially active faults (~ a few hundred meters), structures of Consequence Classes CC2 and CC3 may be constructed if:
  - a. a continuous stiff foundation is provided
  - b. soil cover exceeds a certain thickness  $H_{cov}$
- Bearing piles should not be designed to cross the potential fault plane, and their tip should be located at least 10 diam. above this plane.
- It is not required to consider simultaneous effects of fault rupture and structural vibrations due to ground shaking.

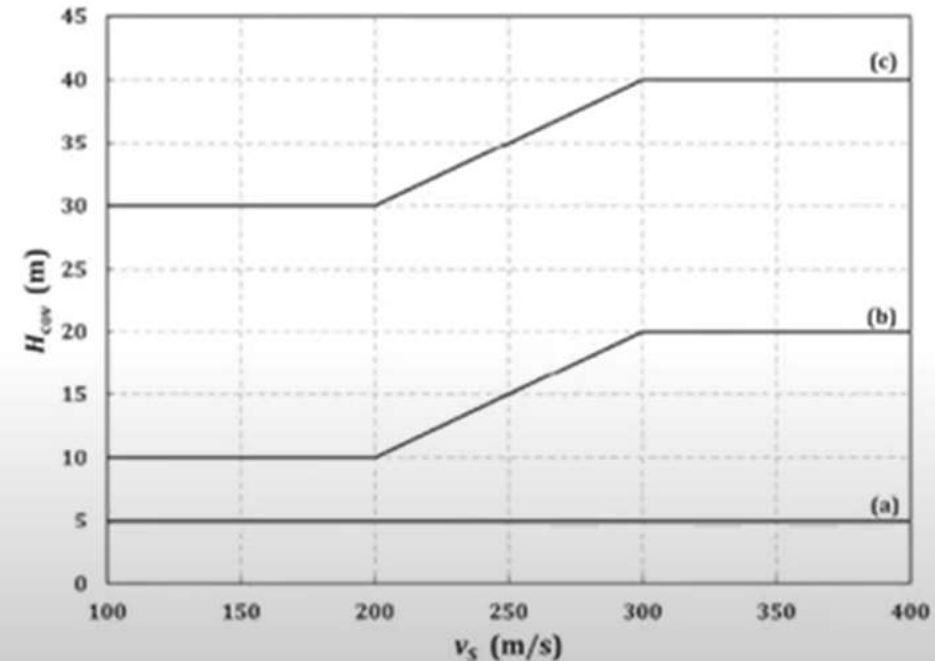

Figure 7.1 — Thickness  $H_{cov}$  of minimum allowed soil cover versus average soil shear wave velocity  $v_s$  within the depth of influence of the foundation: (a) low seismic action class; (b) moderate seismic action class; (c) high seismic action class



## 7.2 Slope stability

- When slope instability affects an adjacent structure, the consequence class and the limit states for the slope should be taken as those of the affected structure.
- Limit states for slopes should be associated to **acceptable permanent ground displacements**.

### Methods of analysis

- **Forced-based approach, FBA** (allowed only if there is no danger of liquefaction or significant reduction of soil strength).
- **Displacement-based approach, DBA** (to be used when an evaluation of displacements is needed).

## 7.2.2.2 Forced-based approach

- **Seismic demand** for the slope is expressed by a **horizontal seismic coefficient**  $\alpha_H$

$$\alpha_H = \frac{a_H}{g} \quad \text{where} \quad a_H = \frac{\beta_H S_\alpha}{\chi_H F_A} = \frac{\beta_H}{\chi_H} PGA_e$$

- $\chi_H > 1$  is a coefficient reflecting the soil nonlinearity and the **amplitude of accepted permanent** ground with different values depending on the considered limit state (DL, SD or NC)
- **Vertical component** of seismic action may be neglected except for high seismic action where it should be taken as half of horizontal.
- **Seismic resistance** of the slope should be expressed by its critical seismic coefficient  $\alpha_C$  (minimum value of horizontal seismic coefficient leading to pseudo-static failure).

Table 7.1 – Values of  $\chi_H$  for slope stability analyses

$\chi_H$	1,5	2,0	2,5
<b>Range of permanent displacements (mm)</b>	30-50	60-100	120-200

NOTE Values of  $\chi_H$  in Table 7.1 are calibrated for the recommended values of material factors and global resistance factors. Values of  $\chi_H$  for other values of the material factors or global resistance factors are not provided in this standard.

### 7.2.2.3 Displacement-based approach

- Performance of a slope should be evaluated based on the **acceptable permanent displacements** (depending on, for example, adjacent structure)
- Permanent displacements may be calculated using either a non-linear dynamic analysis or a rigid block model – NB: rigid-block model cannot be used where there is significant reduction in soil strength unless the residual soil shear strength is used.
- The seismic demand of the slope is expressed as the **permanent displacement** produced by the seismic action and the **seismic capacity** is expressed as the maximum acceptable permanent displacement

## 7.3 Potentially liquefiable soils

- Liquefaction assessment should be performed for **free-field** site conditions (ground surface elevation, ground water level) prevailing during the design service life of the structure
  - Note: The water level (Clause 6.2) should be equal to its **quasi-permanent** value (per EN 1990:2020), – a simple definition is the value averaged over a chosen time period.
- Susceptibility to liquefaction (more specific in Annex B)
  1. Sands, gravelly sands, silts, mine tailings, and fine-grained soils with plasticity index not greater than 15 should be evaluated for liquefaction susceptibility.
  2. Soils with clay fraction greater than 15% are not susceptible to liquefaction.
- Liquefaction assessment may be neglected for magnitudes smaller than  $M_{wT} = 5$  (**NDP value**)
- For structures on foundations other than piles, in **low seismic action** classes, the consequences of liquefaction may be ignored if liquefaction is found at **depths greater than 15 m** below the foundation base.

— Centriguge model test — Numerical Modeling

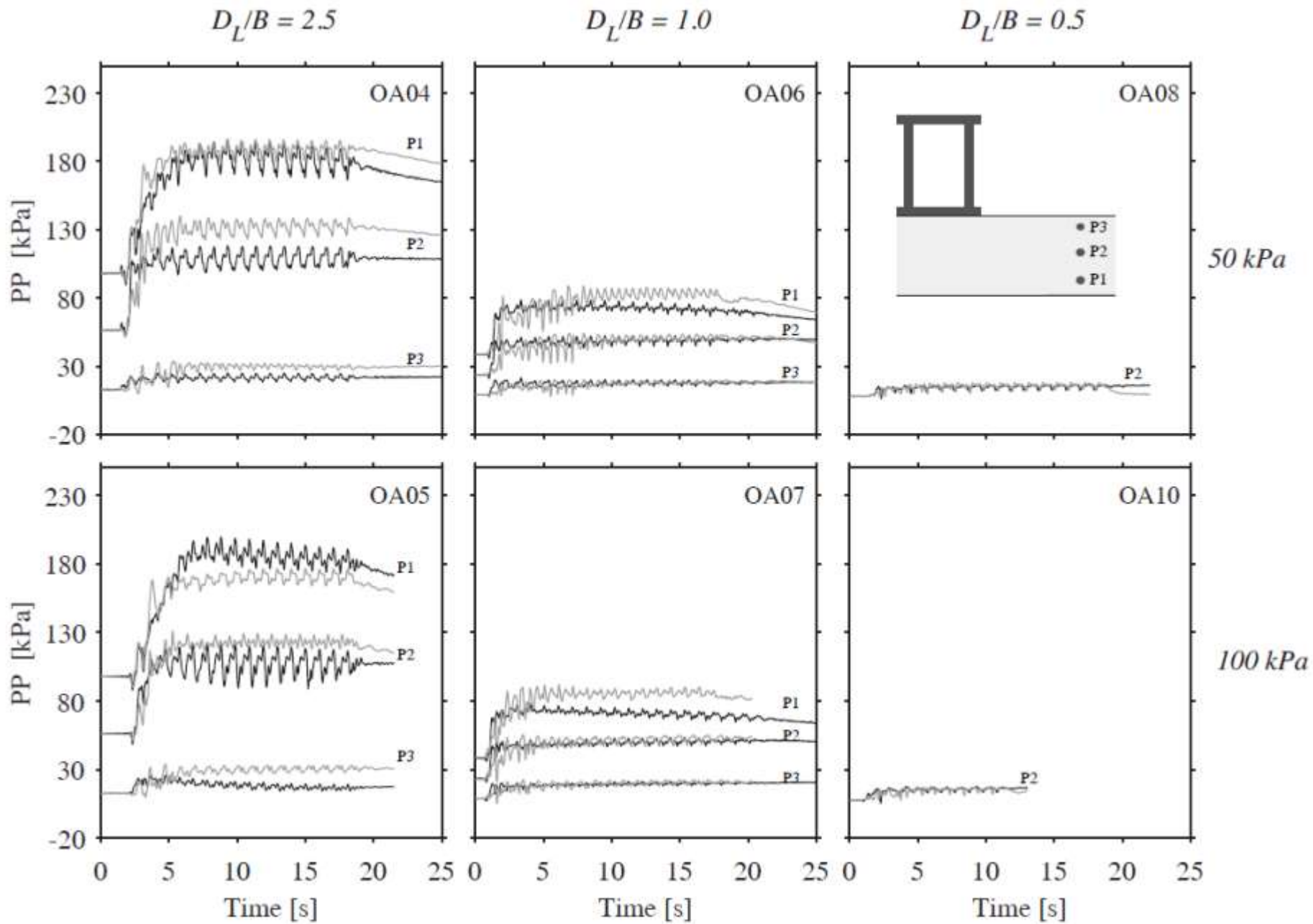

## 7.3.5 Liquefaction assessment

More specific and more informative compared with **2004 version**

- Liquefaction assessment follows the conventional procedure using the resistance factor approach (MFA):

$$(CRR/\gamma_{cy,u})/CSR \leq 1,0$$

$$CRR = \frac{\tau_{cy,u}}{\sigma_v} \quad CSR = 0,65 \frac{\tau_{max}}{\sigma_v} \quad \tau_{max} = \alpha_H r_d \sigma_v \quad \Rightarrow \quad \alpha_H \text{ computed with } \beta_H = \chi_H = 1,0$$

- For strongly **heterogeneous** soil profiles,  $\tau_{max}$  should be determined from a GRA.
- CRR should be evaluated using accepted SPT or CPT based methods, and **conventional correction factors** may/should be applied (**Informative Annex B**)
  - a) SPT hammer impact energy (for SPT-based methods); b) overburden pressure; c) fines content, d) thin layer correction; e) ageing effects; f) shaking history; g) earthquake magnitude correction; h) effective overburden pressure; i) initial static shear stress correction
- For **finer-grained soils** (described in Annex B) and high seismic action classes laboratory tests should be used.

## 7.4 Settlements of soils under cyclic loading (moderate/high seismicity classes)

More specific and more informative compared with **2004 version**

- Susceptibility of **unsaturated loose, coarse-grained soils** to densification and settlements caused by cyclic stresses should be evaluated. Settlements and densification may be estimated using empirical relationships (Annex C).
- Settlements in saturated coarse-grained soils due to dissipation of excess pore water pressures due to earthquake should be considered (Annex C).
- Settlements in **soft fine-grained soils** due to cyclic degradation under ground shaking and dissipation of induced excess pore water pressures should be addressed.
- Densification and settlement potential of soils may also be evaluated with appropriate **cyclic laboratory tests**.

## Annex C

- Settlement under a building

$$\ln(D_S) = c_1 + 4,59 \ln Q_L - 0,42 (\ln Q_L)^2 + c_2 LBS + 0,58 \ln \left[ \tanh \left( \frac{H_L}{6} \right) \right]$$
$$-0,02 B_b + 0,84 \ln \left( \frac{CAV_{dp}}{g} \right) + 0,41 \ln(S_1/g)$$

$$CAV_{dp} = \sum_{i=1}^n \left[ H_{heav}(PGA_i - 0,25) \int_{i-1}^i |a(t)| dt \right]$$

- Lateral spreading due to liquefaction

$$\lg D_H = -16,71 + 1,532 M_w - 1,406 \lg R^* - 0,012 R + 0,592 \lg a_1 + 0,540 \lg a_2$$
$$+ 3,413 \lg(100 - a_3) - 0,795 \lg(a_4 + 0,1)$$

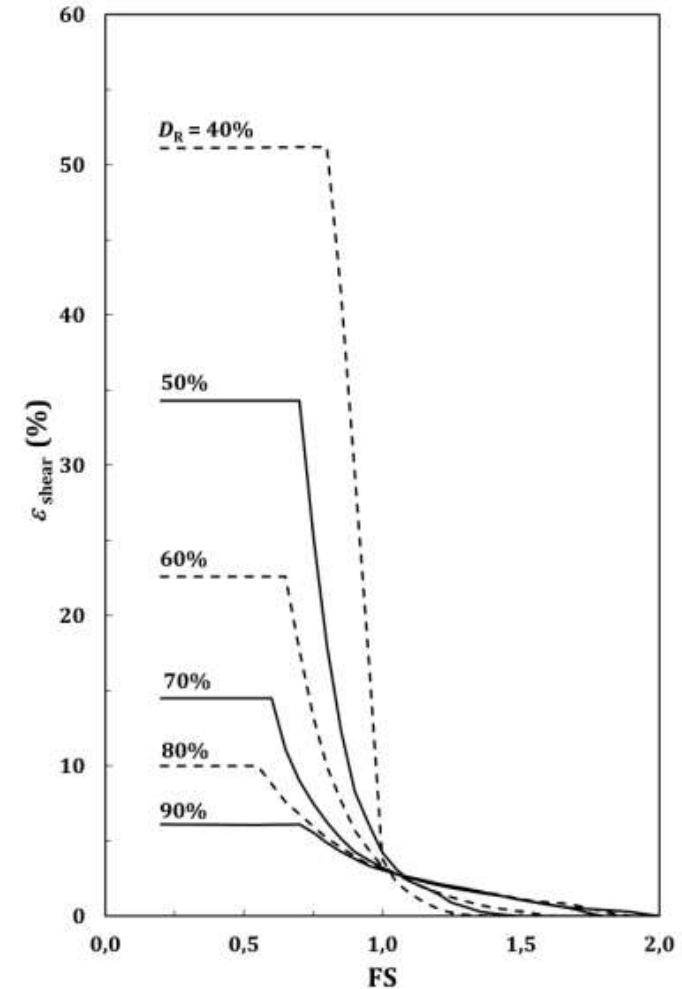



## 7.5 Site-specific response analyses

- When the relevant conditions in EN 1998-1-1 apply (namely, clauses 5.1.2(2) and 5.2.2.1(4) related to special ground conditions or type of seismic analysis), the seismic actions required for the analyses in this chapter and those for foundations, retaining walls and underground structures (Chapters 8-11) should be derived from site-specific GRAs. For this purpose, one could use conventional **total stress methods** (per EN 1998-1-1 Annex B).
- If the ground response analysis is carried out in terms of **effective stresses**, a non-linear constitutive model (accounting for, for example, the volumetric and deviatoric behaviour of the soil and drainage conditions) should be considered.

# EN1998-5-8 SSI SOIL STRUCTURE INTERACTION

- 8.1 GENERAL REQUIREMENTS
- 8.2 ANALYSIS OF INERTIAL EFFECTS
- 8.3 MODELLING OF KINEMATICS EFFECTS
- 8.4 COMBIANTION OF INERTIAL AND KINEMATICS EFFECTS FOR INTERNAL FORCES
- CHAPTERS ON FOUNDATION, RETAINING STRUCTURES, UNDERGROUND STRUCTURES

# EC8-5-8 SSI SOIL STRUCTURE INTERACTION

## 8.1 General requirements

The analysis of seismic SSI effects should consider two effects:

- a) **Inertial effects** that modify the dynamic response of the structure by changing the fundamental period and damping of the soil-structure system.
  
- b) **Kinematic effects** that modify the seismic excitation at the base of the structure with respect to the free-field, and produce loading of foundation elements.

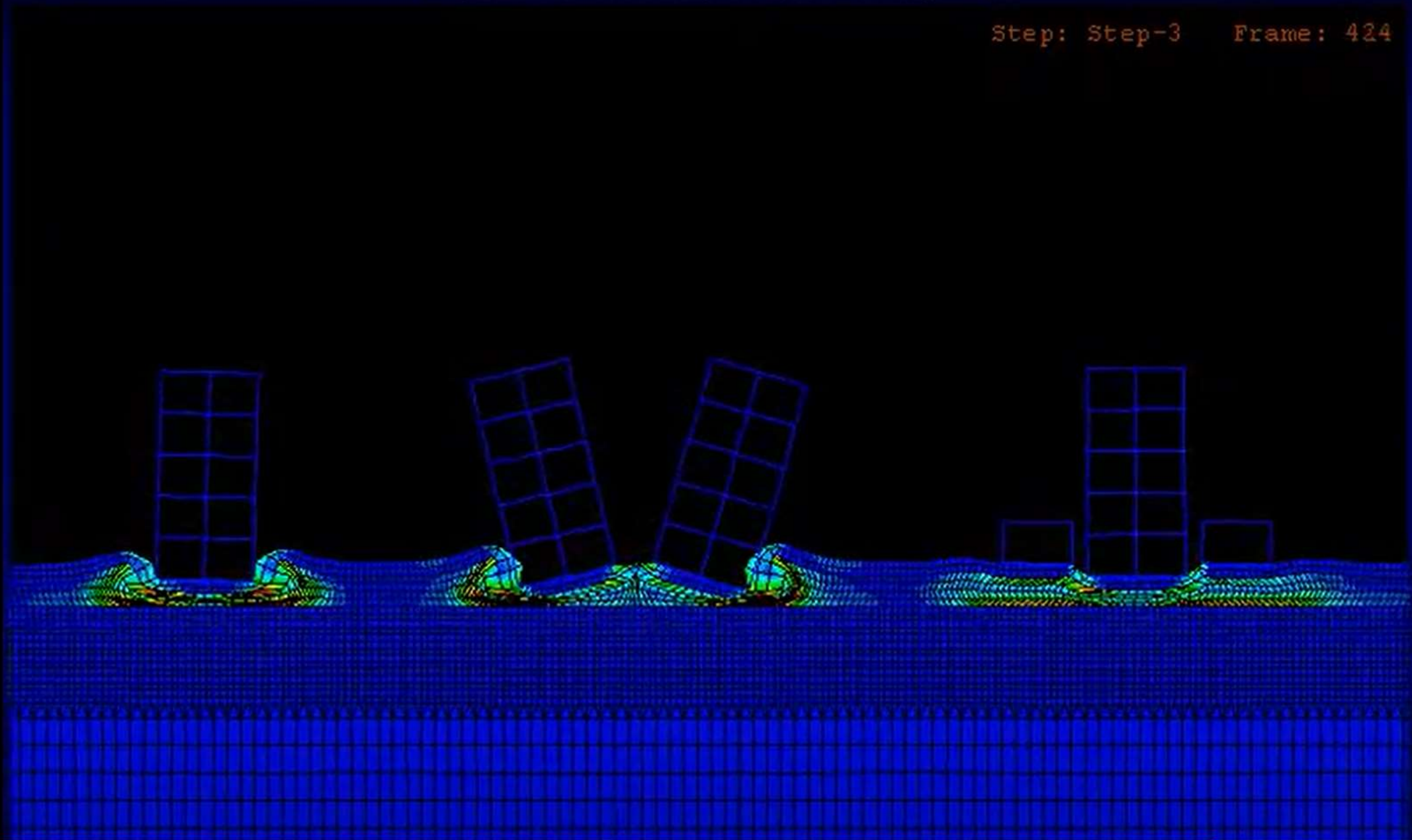

0:08 / 0:10



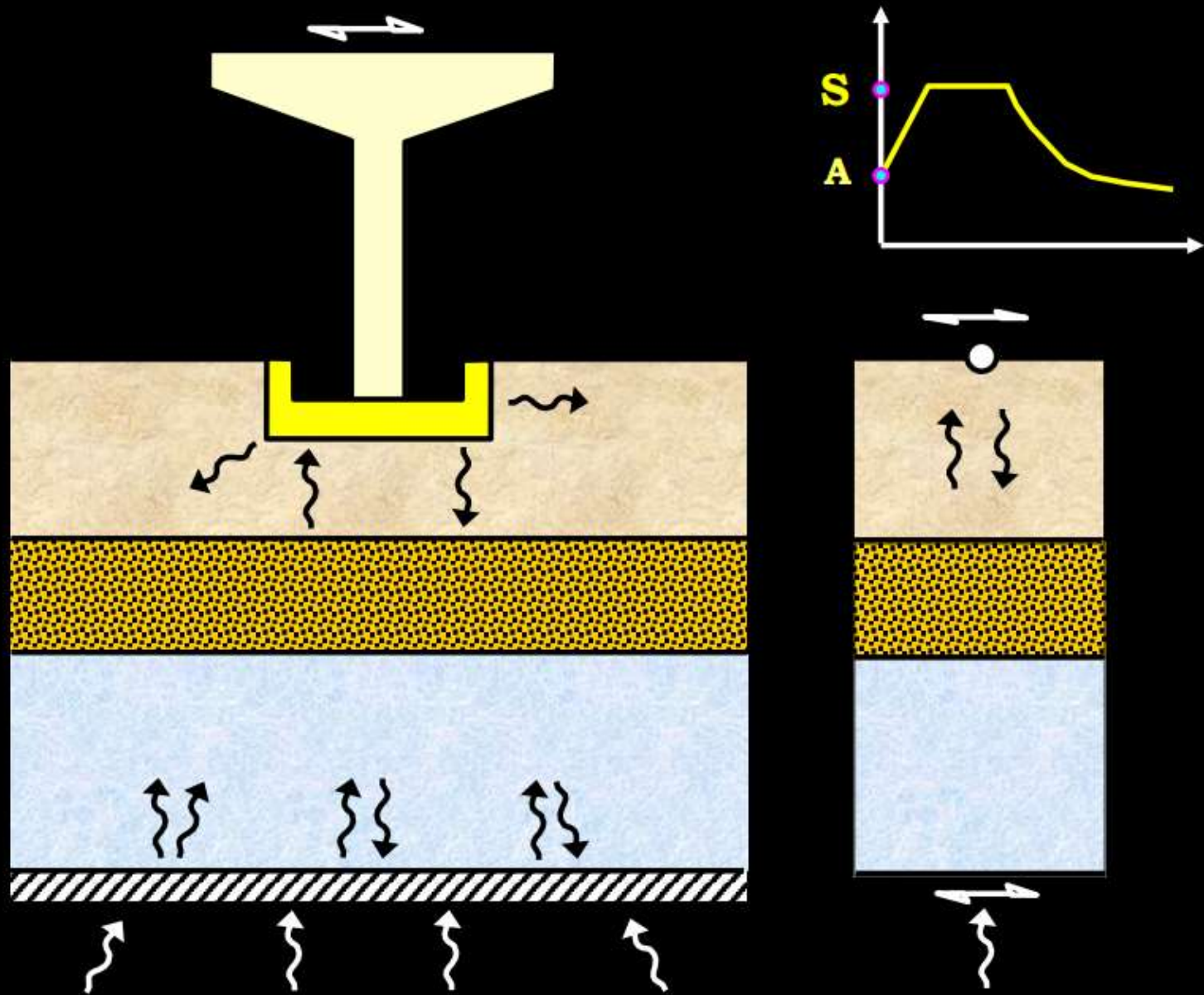

*Kinematic  
Effects*

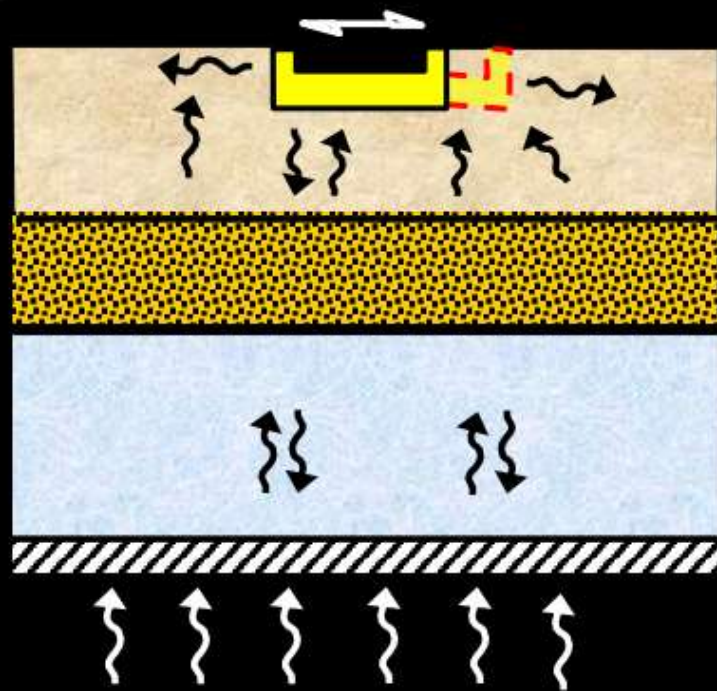
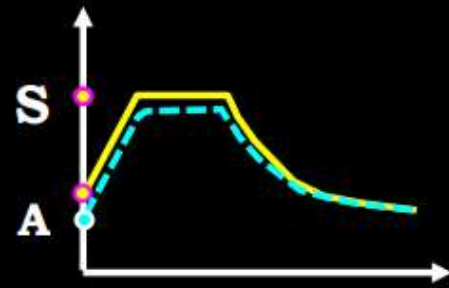

*Inertial  
Loading*

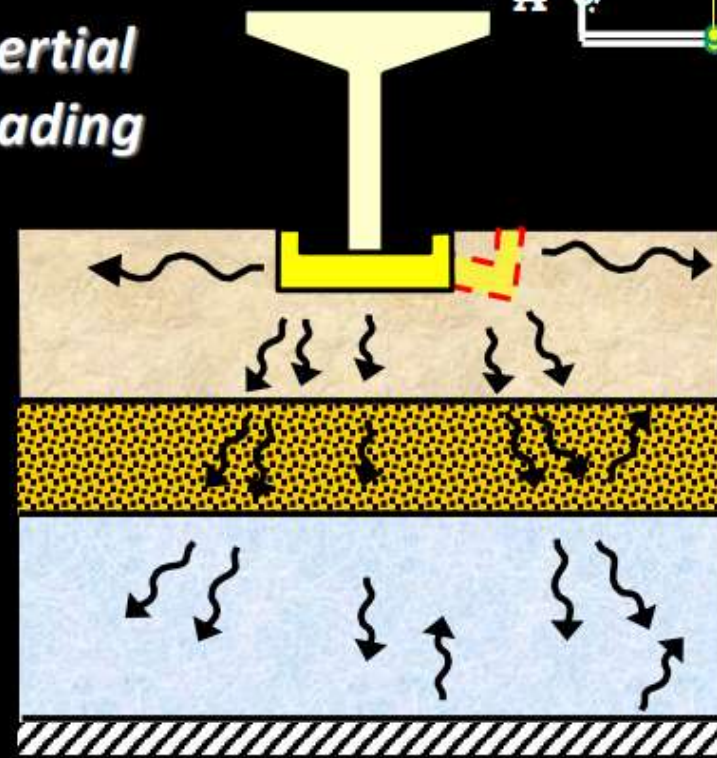
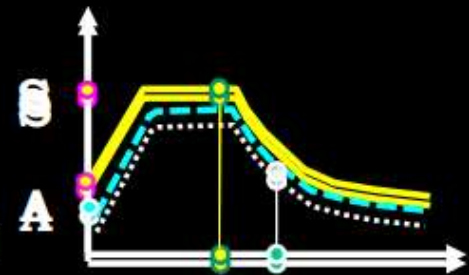

## “Kinematic” Effects

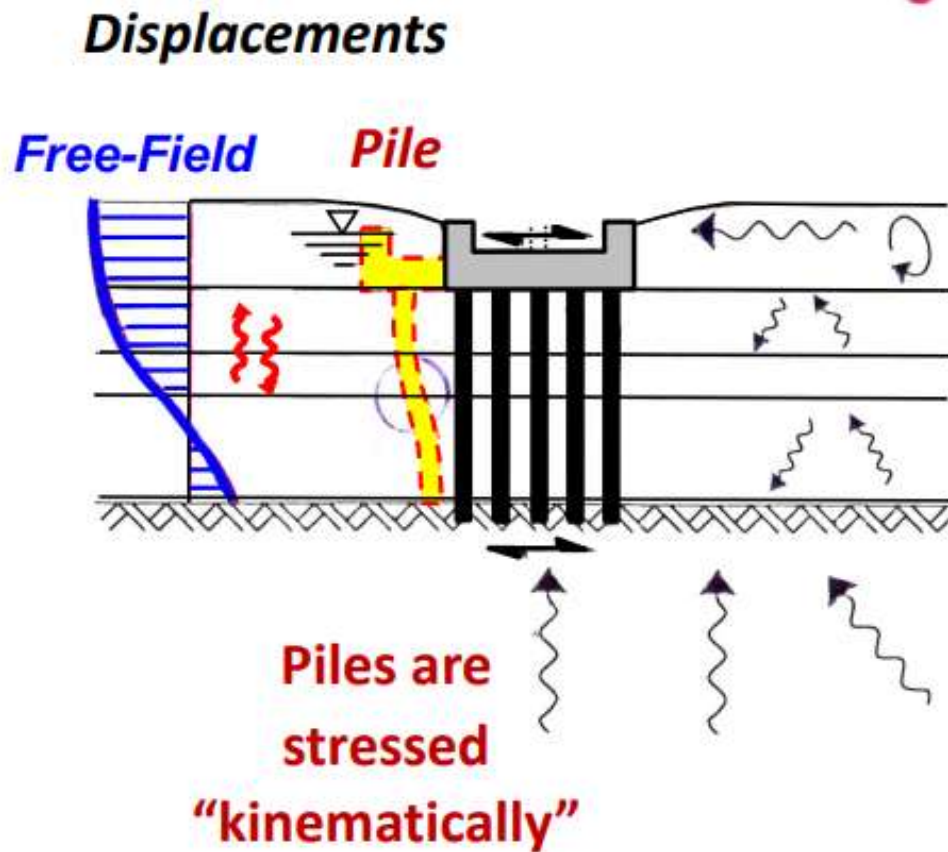

## “Inertial” Loading

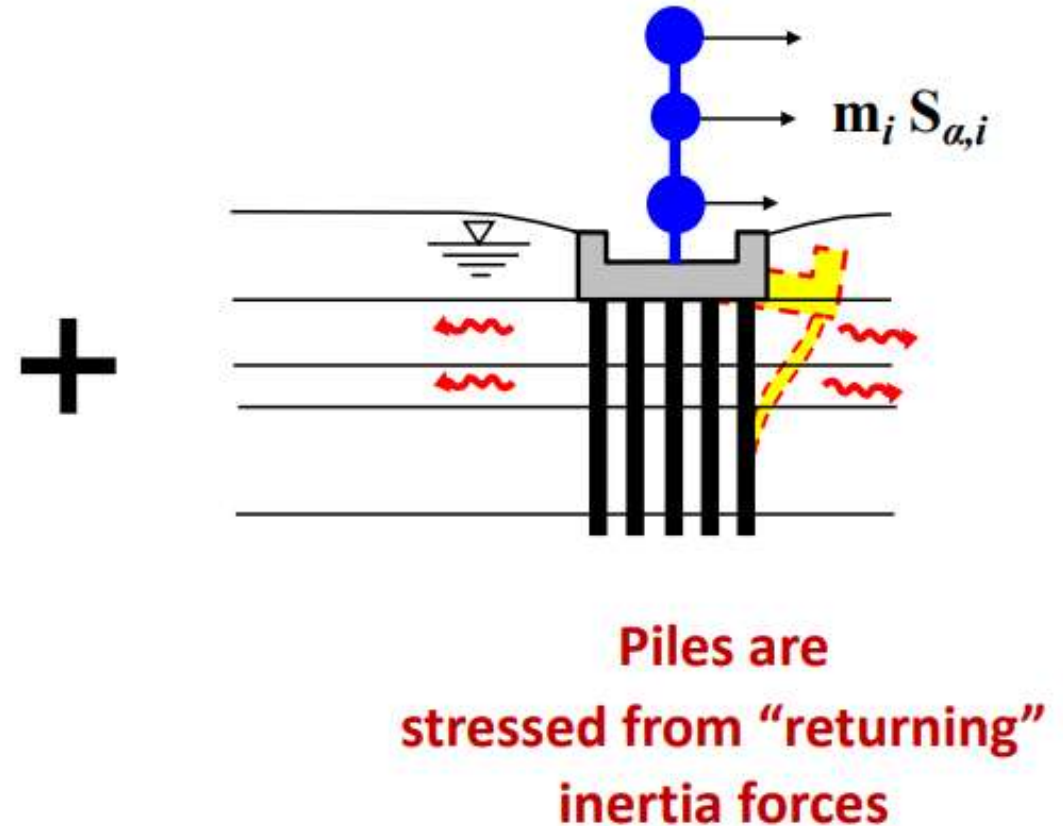

**(5) The inertial effects of SSI should be considered when at least one of the following applies:**

- a) When increasing the fundamental period **increases spectral accelerations**.
- b) When the **displacement of the structure controls** the width of joints separating nearby buildings (existing or planned), or other performance criteria.
- c) For structures supported on soft soils in which  $v_s$  averaged over a depth equal to **3 times the maximum foundation width** in case of footings or to the maximum width in case of a raft foundation, is less **< 250 m/s**.
- d) Structures with geometric non-linearity ( **$P - \Delta$  effect**) plays a significant role.



**(5) The inertial effects of SSI should be considered when at least one of the following applies:**

- a) When increasing the fundamental period **increases spectral accelerations**.
- b) When the **displacement of the structure controls** the width of joints separating nearby buildings (existing or planned), or other performance criteria.
- c) For structures supported on soft soils in which  $v_s$  averaged over a depth equal to **3 times the maximum foundation width** in case of footings or to the maximum width in case of a raft foundation, is less **< 250 m/s**.
- d) Structures with geometric non-linearity ( **$P - \Delta$  effect**) plays a significant role.

## 8.1

### (6) Kinematic Modification of Foundation input motion should be considered:

- a) in case of **deep** foundations (piles, caissons)
- b) foundations **embedded to a depth of at least two floors**, or to a depth  $> L/4$ , if the foundation **vertical surfaces is in full contact** with the surrounding ground
- c) abutments of **bridges with large embankments**, or integral bridges without specific provisions for minimizing SSI effects
- d) very large foundations with  **$L$  or  $B > 50$  m** consisting of a slab, or a single box foundation, or footings interconnected with tie beams.

**(7)** For **flexible pile** foundations, **modification of the free-field** motion, as required in 8.1(6)a), **may be neglected** and the free-field motion may be used for the foundation input motion.

**(8)** A pile foundation may be considered as flexible when

$$E_p / E_s \leq (L_p / 1,5 d)^4 \quad \text{from } L_p \geq L_c \approx 1,5 d (E_p / E_s)^{0.25}$$

where  $L_p$  and  $d$  are the pile length and pile diameter.

**(9)** **Kinematic** interaction may be **neglected for the vertical** component of the seismic action.

## 8.2 Analysis of inertial effects

(1) Seismic action effects on structure and foundations should be determined with **suitable model** of structure–foundation system supported on the ground.

The ground reaction may be represented by **springs for all degrees of freedom**.

NOTE A rigid foundation has 6 degrees of freedom, 3 translational (in **x, y, z**) and 3 rotational (**rx, ry, rz**, about the x, y and z axes).

(2) **Coupling of horizontal and rotational springs** should be considered for piled foundations, deeply embedded foundations, and caissons.

(3) For foundation shapes (circle, strip, rectangle), piles and ground profiles **values for spring stiffnesses** may be obtained from available **elasticity-based** solutions.

NOTE See **Annex D** for guidance to obtain **stiffness and damping** of foundations and piles.

## ***Footing $B \times L$ on Homogeneous halfspace***

$$K_{xx} = \frac{GB}{2-\nu} \left[ 1,2 + 3,3 \left( \frac{L}{B} \right)^{0,65} \right]$$

$$K_{rx} = \frac{GB^3}{8(1-\nu)} \left[ 0,4 + 3,2 \left( \frac{L}{B} \right) \right]$$

$$K_{yy} = \frac{GL}{2-\nu} \left[ 2 + 2,5 \left( \frac{B}{L} \right)^{0,85} \right]$$

$$K_{ry} = \frac{GB^3}{8(1-\nu)} \left[ 3,6 \left( \frac{L}{B} \right)^{2,4} \right]$$

$$K_{zz} = \frac{GL}{1-\nu} \left[ 0,73 + 1,54 \left( \frac{B}{L} \right)^{0,75} \right]$$

$$K_{rz} = \frac{GB^3}{8} \left[ 4,1 + 4,2 \left( \frac{L}{B} \right)^{2,45} \right]$$

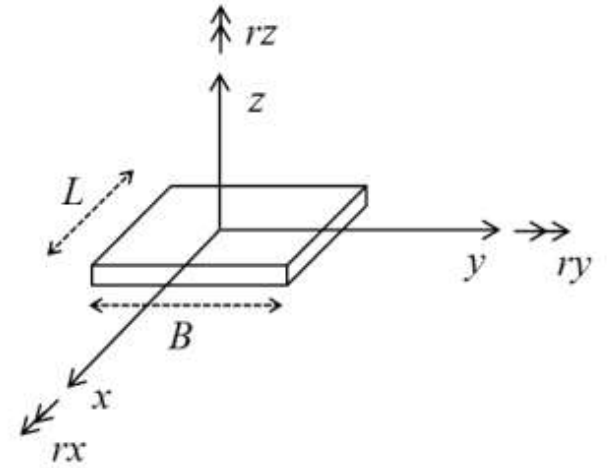

## Translational modes

$$C_{xx} = C_{yy} \approx \rho v_s A_b$$

## Rotational modes

$$C_{ry} = \frac{\rho v_s J_{by}}{1 - \nu} c'_{ry} \rightarrow$$

## On HOMOGENEOUS Halfspace

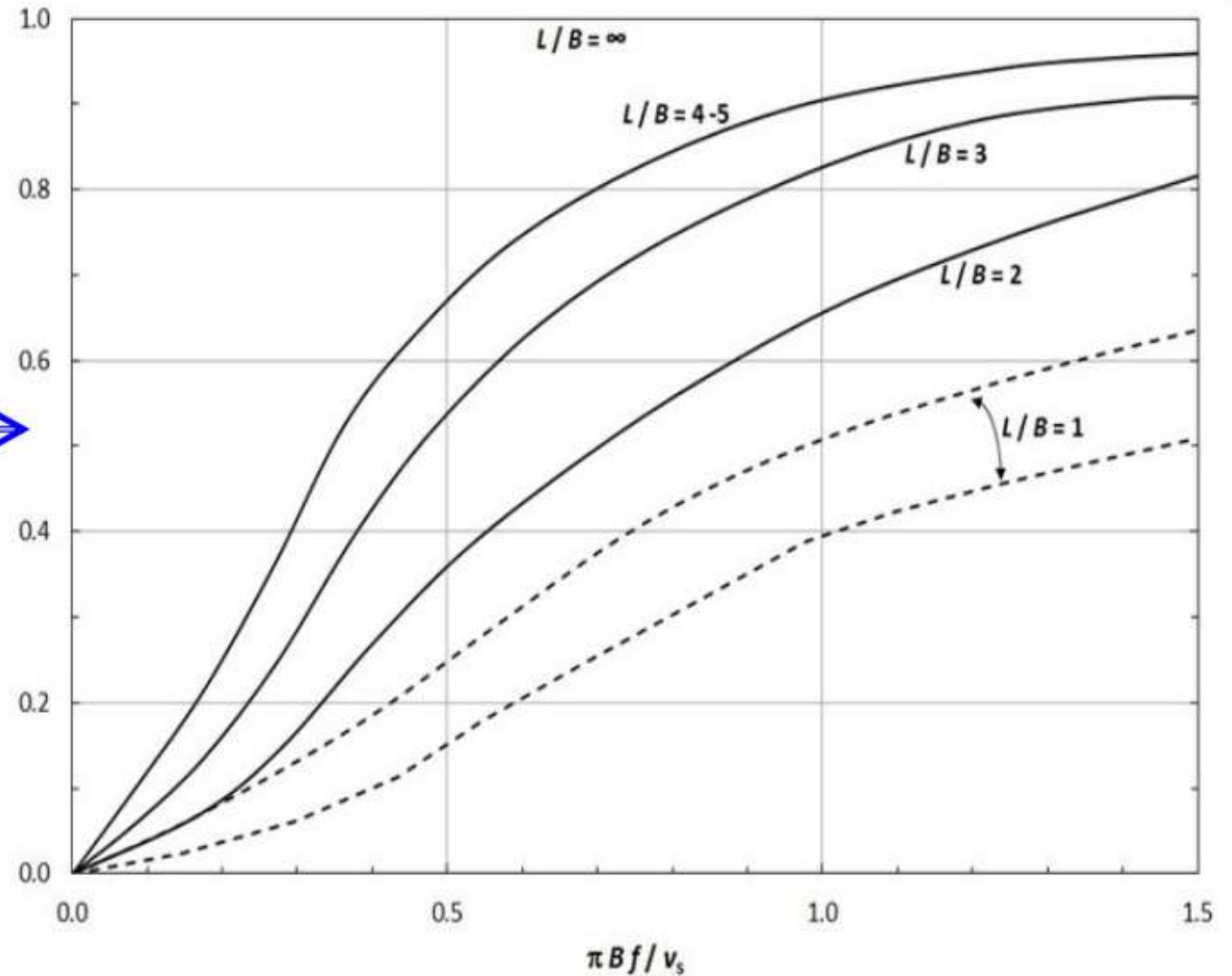

**(4) Frequency-independent stiffness may be assigned to each spring, corresponding to the period of the fundamental mode, accounting for SSI in the considered direction. If this period is difficult to determine reliably, the static stiffnesses may be used instead.**

**(5) For design limit states SD and NC, the equivalent-linear stiffnesses for nonlinear springs to be used should be compatible with the amplitude of horizontal displacements and rotations of the foundation.**

**(6) To apply (5), the equivalent-linear stiffnesses of each spring may be calculated with the soil moduli compatible with the strain amplitude developed in the free-field.**

## 8.2.1 Force-based approach

- (1) **Radiation damping** may be used **only for periods  $T < T_0$**  (the fundamental period of the soil deposit).

Unless supported by numerical calculations which model the layers properties down to a depth where  $v_s > 600$  m/s, radiation damping should be **limited to 20 %**.

- (2) Numerical analyses should comply with 8.5.



$$C_{ry} = \frac{\rho v_s J_{by}}{1 - \nu} c'_{ry}$$

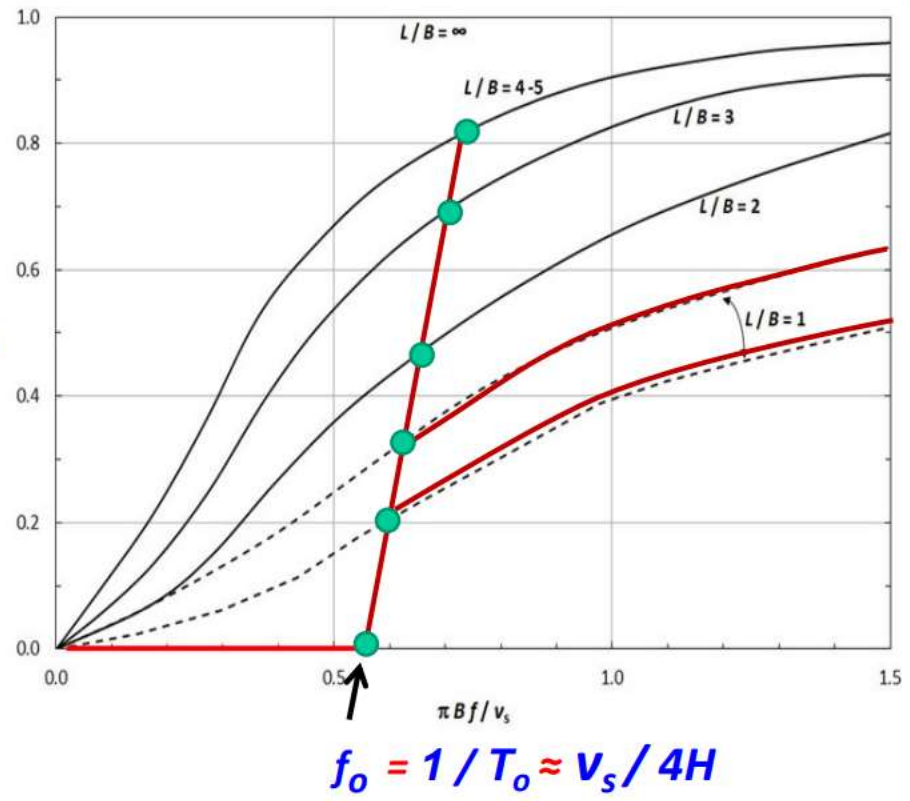

### 8.2.2.2 Time history analyses

(1) The effect of inertial SSI in time history analyses may be taken into account by modelling the foundation/ground system with springs and dashpots.

(2) A **frequency-independent stiffness** value may be assigned to each spring, corresponding to the **period of the fundamental mode**, accounting for SSI in the considered direction.

NOTE The frequency dependence of the springs and dashpots can be modelled in time history analyses with lumped models of constant springs, dashpots and masses.

(3) Radiation damping ( $C_{\alpha}$ ) may be added to material damping ( $\xi$ ): 
$$C_{\alpha t} = C_{\alpha} + \xi \frac{K_{\alpha} T}{\pi}$$

NOTE 1 **Annex D** provides guidance for **stiffness and damping**.

NOTE 2 **Radiation damping** is strongly affected by **ground layering**. Solutions for a homogeneous elastic half-space result in **unrealistically large values** of damping.

### 8.3 Modelling of kinematic effects

(1) Kinematic interaction effects may be calculated in accordance with 8.5 as part of the **whole structure-foundation-soil system**, or with a **separate analysis** in which only the foundation, without mass, and the soil are included.

(2) The second type of analysis in (1) may be performed either through FE/FD.

For **piles a suitable Winkler type model** may be used with lateral soil springs and dashpots representing the action of the soil in contact with the foundation elements.

(3) In FE/FD of pile–soil system, the **seismic excitation** should be imposed **at the base of soil stratum** and lateral boundaries should be capable of **deforming as the free-field**.

# DYNAMIC WINKLER MODEL

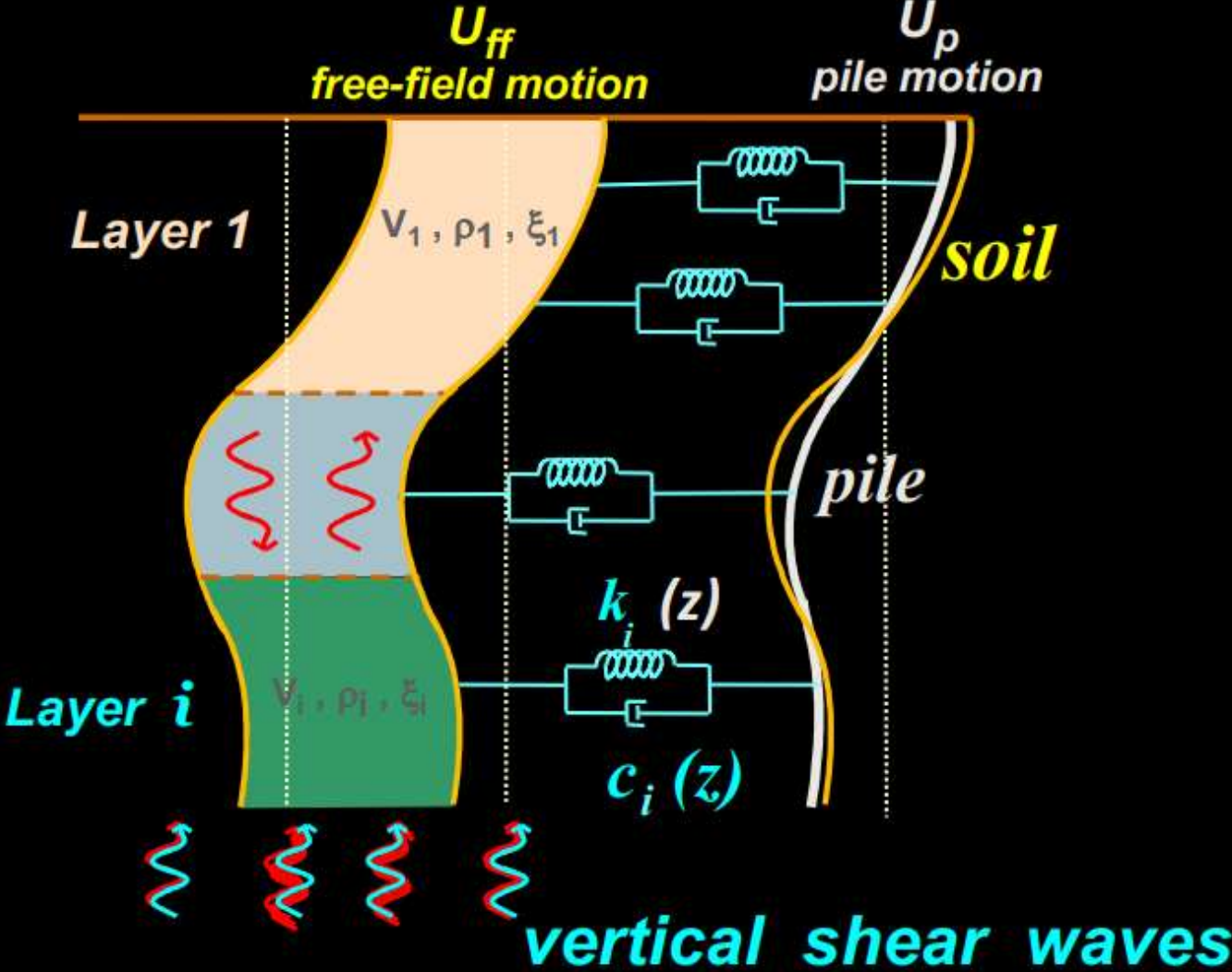

(4) With **Winkler** modelling, ground should be discretised into **horizontal layers**. One-dimensional ground response analysis should be conducted to obtain the **time-histories of displacement at each layer**. These displacements should be **imposed at the supports** of the lateral springs-and-dashpots.

(5) With **Winkler** modelling, an alternative to (4) may be used to impose the ground displacements by representing the action of the surrounding ground with a **shear beam** connected to the free ends of the springs and dashpots.

(6) In (5), the shear beam should have masses an order of magnitude larger than the pile masses.

(7) To obtain the induced **bending moments** in a pile, the analysis in (4) may **replace** the time histories of displacements with the respective **peak values to be imposed statically** at the supports of the springs, with the dashpots neglected.

## 8.2.2 Displacement-based approach

### 8.2.2.1 Nonlinear static analysis

(1) In non-linear static analysis of surface or shallow foundations, translational and rotational **inelastic springs** may be used.

(2) When springs are not used, the **lateral force–displacement relation** of the foundation-soil system under large deformations may be calculated from a suitable **non-linear static analysis** in which the inelastic ground is modelled by FE / FD.

The possibility of **uplift on the tension side** of the foundation, as well as of **slippage at the ground-foundation** contact surface, may be included in the model.

## 8.4 Combination of inertial and kinematic effects for internal forces

(1) If inertial and kinematic effects are evaluated separately, the forces in the foundation elements from the two analyses may be combined according to either a) or b):

- a) when the frequency of the mode contributing most to the SSI response differs by more than 15% from the fundamental frequency of the soil deposit, the action effects are combined with SRSS rule (square root of the sum of the squares)
- b) when the condition in a) is not satisfied, the absolute values of the action effects of the two analyses are summed up.

# EC8-5-9 FOUNDATION SYSTEMS

## Three main topics

- Shallow foundations
- Pile foundations
- Design values and verifications

## One associated Annex (informative)

- Annex E - Seismic bearing capacity of shallow foundations



## Main principle:

(1) The **foundation** of a structure in a seismic zone shall transfer the action effects in the structure for the seismic design situation, **from the structure to the ground**, without structurally unacceptable permanent displacements.

## Attention to:

- Strain dependence and cyclic effects
- Verifications using material factor approach (MFA) or resistance factor approach (RFA), and same partial factors for materials as in design of structural members
- Different foundation types in the same structure imply additional requirements
- **Force-based approach (FBA) and displacement-based approach (DBA)**

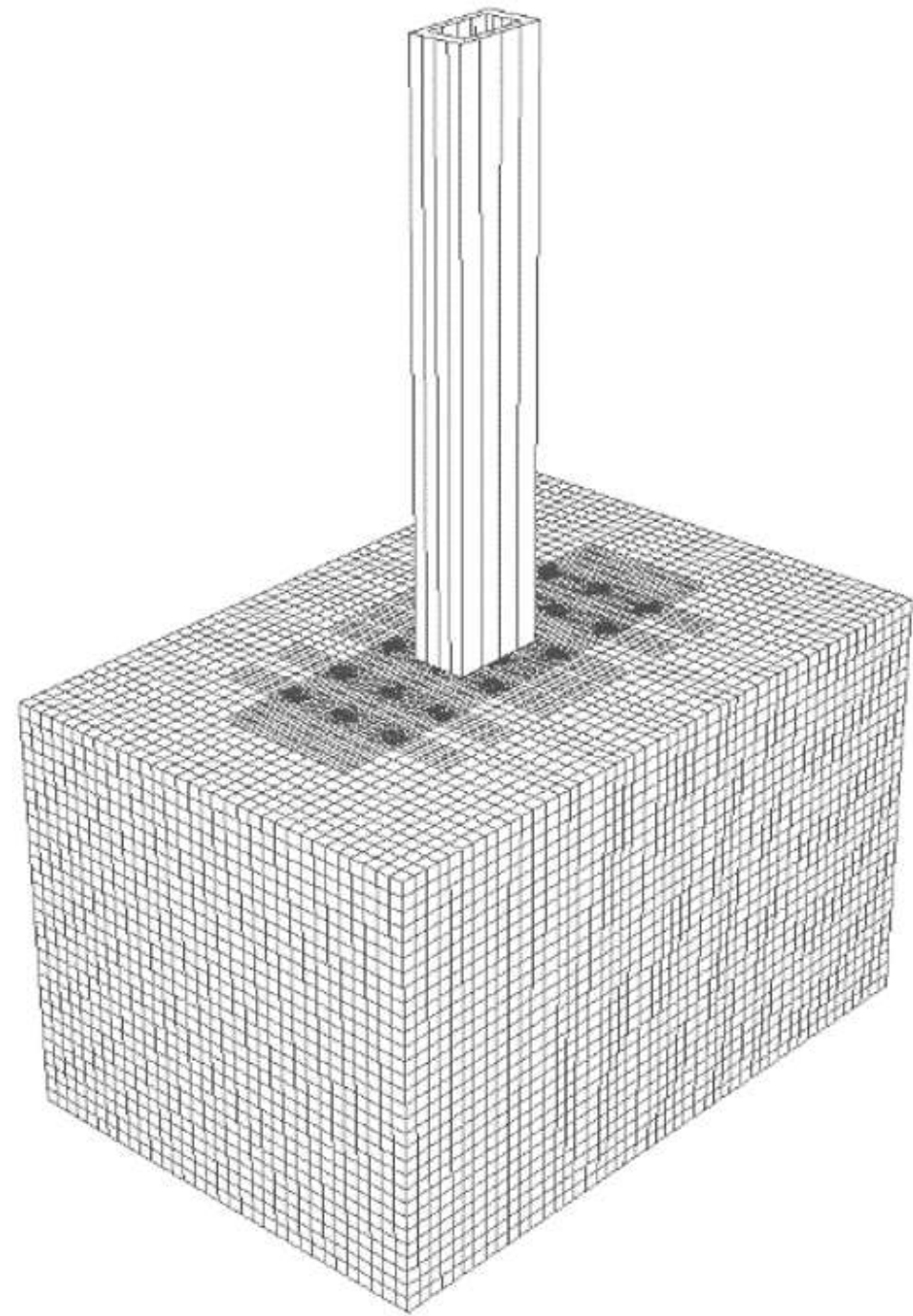

## 9.2 Design values of the action effects

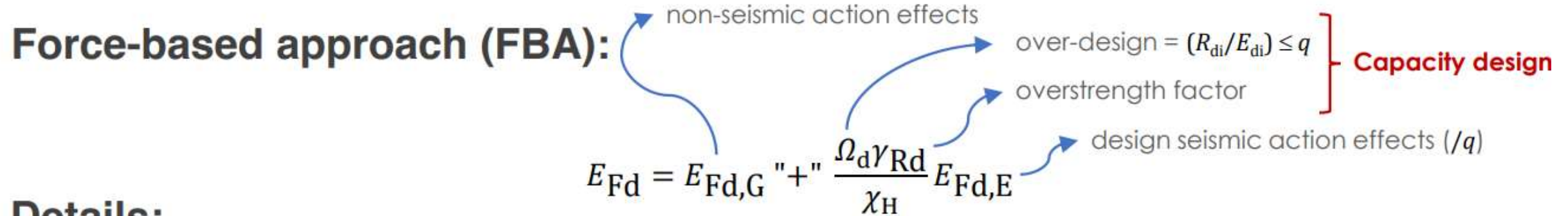

### Details:

- To verify the foundation elements  $\rightarrow \chi_H = 1,0$
- DC1  $\rightarrow \Omega_d \gamma_{Rd} = 1,0$
- DC2 or DC3:
  - **Raft or caisson foundations** (and foundation beams designed to DC1)  $\rightarrow \Omega_d \gamma_{Rd} = 1,25 q_R$
  - **Isolated footings or non-yielding piles**  $\rightarrow \Omega_d \gamma_{Rd} = 1,25 q_R$  (overturning moment and shear);  
 $\Omega_d \gamma_{Rd} = \Omega$  (vertical force,  $\Omega$  as defined in DC2 for each material and structural type)
  - **Yielding piles** (and foundation beams designed to DC2 or DC3)  $\rightarrow \Omega_d \gamma_{Rd} = 1,0$

## 9.2 Design values of the action effects

### Force-based approach (FBA):

$$E_{Fd} = E_{Fd,G} + \frac{\Omega_d \gamma_{Rd}}{\chi_H} E_{Fd,E}$$

non-seismic action effects

over-design =  $(R_{di}/E_{di}) \leq q$

overstrength factor

design seismic action effects ( $/q$ )

**Capacity design**

amplitude of accepted permanent displ.

### Details:

- DC2 or DC3:

➤ For foundation soil capacity →  $\Omega_d \gamma_{Rd} = 1,2$  (bearing capacity) and **1,0** (sliding)

sliding is allowed, but it should take place before bearing capacity failure which may cause permanent tilting and is less controllable

## 9.3 Foundation horizontal connections

- Effects in the structure due to horizontal relative displacements between foundation elements should be calculated and designed for

May be up to 1,0 m above the bottom face of footings or pile caps

- ✓ Foundations are on the same horizontal plane and tie-beams or an adequate foundation slab are provided at the level of the footings or pile caps
- ✓ Adequate detailing of tie-beams and design for prescribed nominal axial force value
- ✓ Tie-beams may be omitted for ground category A or if relative foundation displacements are considered in the design of superstructure

## 9.4 Surface and shallow embedded foundations

### Bearing capacity verification:

#### FBA

- Combination of  $N_{Ed}$ ,  $V_{Ed}$ , and  $M_{Ed}$  in the seismic design situation

Annex E for interaction surface + inertia forces on ground, or EC7-3

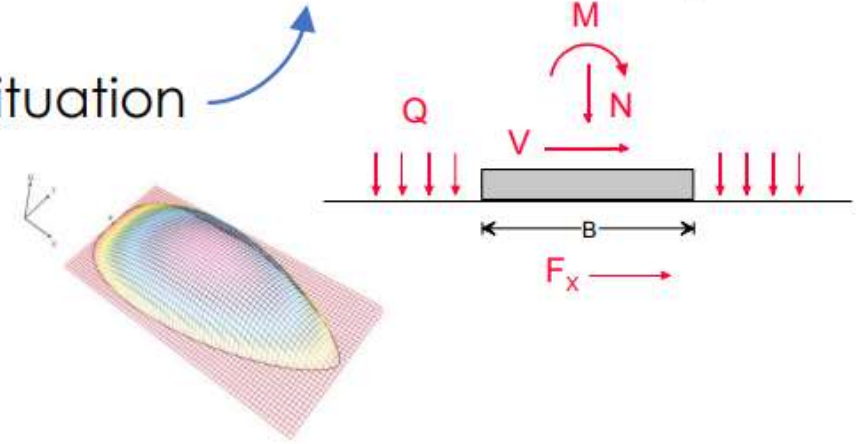

#### In both FBA and DBA

- Same  $\chi_H$  as for sliding
- Inertia forces in ground (may be neglected in several cases)
- In undrained conditions, use total stresses in general (may use effective stresses if excess pore water pressure built-up is limited)

## 9.4 Surface and shallow embedded foundations

### Rotational failure verification:

- **Uplift allowed at any LS** (seismic protection by rocking and uplift allowed if permanent rotations and settlements are acceptably small)
- FBA if uplifted area is  $< 1/3$ , otherwise non-linear DBA

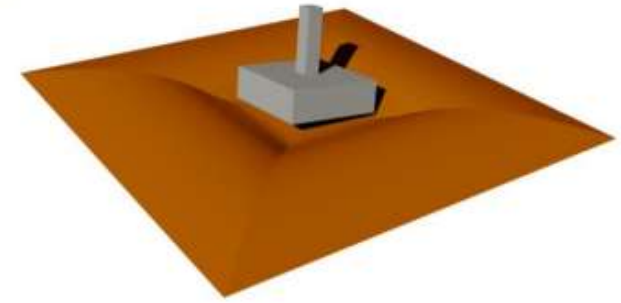

### Verification of settlements:

- Check for free-field conditions in low seismic action class
- Additional foundation settlement for moderate and high seismic action classes
- Ground improvement if needed, global resistance factor for bearing capacity may also be adopted

## 9.4 Surface and shallow embedded foundations

- Requirements for **raft foundations** are similar to the ones for footings
- Structural design and detailing rules, supported on EN 1998-1-2

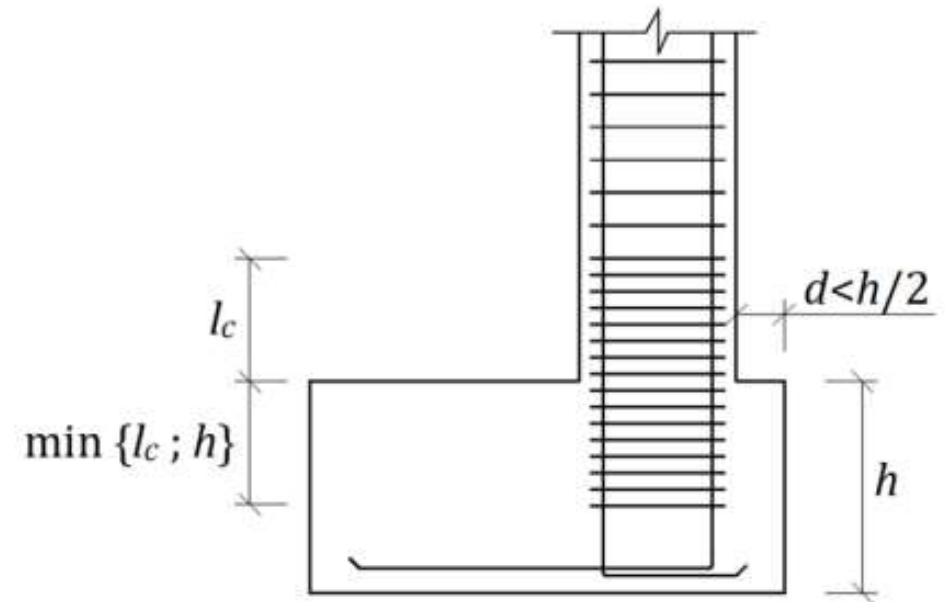



## 9.5 Pile foundations

### Methods of analysis (9.5.3)

#### Group of piles:

- Cap base-ground interface strength and stiffness limited to 30% of full contact assumption
- In FBA, limit to 30% of horizontal passive resistance of ground in front of the cap

And no contribution if minimum pile spacing  $< 6 D$

#### DBA

- Analysis of inertial and kinematic effects to provide **maximum displacement** of the piles and corresponding **curvature demand**
- Numerical methods with appropriate **boundary conditions** and consideration of **gapping** between the pile and soil (if unfavourable)

Gapping tends to increase the flexibility of the system and to reduce the forces transmitted to the superstructure, but it can also increase the internal forces in the pile and its displacements

## 9.5 Pile foundations

- Kinematic effects may be neglected:
  - In CC1 structures or
  - For low seismic action class or
  - Stiff and medium ground classes or
  - No strong stiffness contrast in successive layers:
    - ❖ “if the shear wave velocity ratio between two successive layers along the pile length, excluding layers thinner than 3 diameters, does not exceed 2,0 and if the equivalent shear wave velocity in the shallowest five diameters is larger than 150 m/s”
- **Battered** (inclined) piles should also be designed for **residual action effects** after the earthquake

## 9.5 Pile foundations

### Design verifications

- Special care with piles crossing potentially liquefiable layers, considering:
  - **passive-type forces** exerted by the moving soil layers above the liquefied layer
  - **kinematic constraints** imposed on the pile deformation by the superstructure
  - magnitude of the liquefied **soil displacements**
  - **negative skin friction** (in post-earthquake situation)
    - Also for soil settlements in non-liquefiable soils

## 9.5 Pile foundations

### Design verifications (9.5.4)

(1) The pile-soil system shall be designed to carry the forces transmitted by the superstructure to the piles heads. In addition, each pile shall be designed to carry the combination of axial loads, bending moments and shear forces in the seismic design situation.

- Design at SD and NC for yielding or non-yielding, avoiding brittle mechanisms and instabilities

Specific detailing requirements, namely for in-ground and pile head plastic hinge regions

Shear resistance verification with overstrength factor  $\gamma_{Rd} = 1,2$  applied to the lateral bearing capacity of soil-pile system

# Annex E (informative) - Seismic bearing capacity of shallow foundations

## Scope

- Calculation of the seismic **foundation bearing capacity** of strip, rectangular and circular surface and embedded foundations

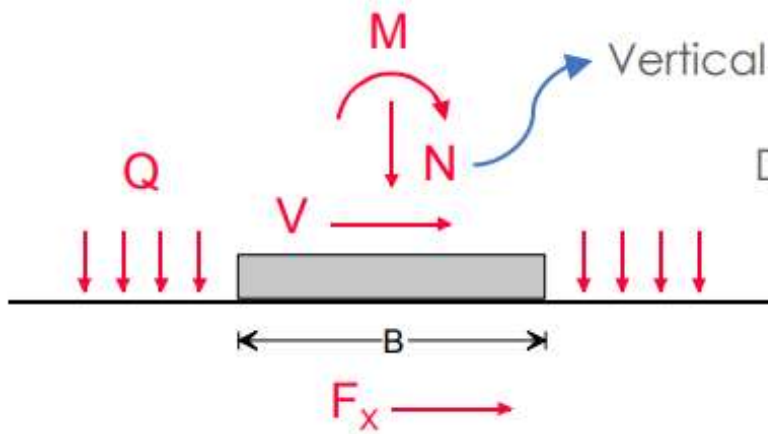

Vertical bearing capacity  $N_{\max}$  as in EC7-3

Dimensionless generalised forces:

$$\begin{cases} \bar{N} = \frac{N_{Ed}}{N_{\max}} \\ \bar{V} = \frac{V_{Ed}}{N_{\max}} \\ \bar{M} = \frac{M_{Ed}}{B N_{\max}} \\ \bar{F} = \kappa \frac{\rho a_H B}{\bar{c}} \end{cases}$$



And expressions for **interaction diagram** (as in structural design):

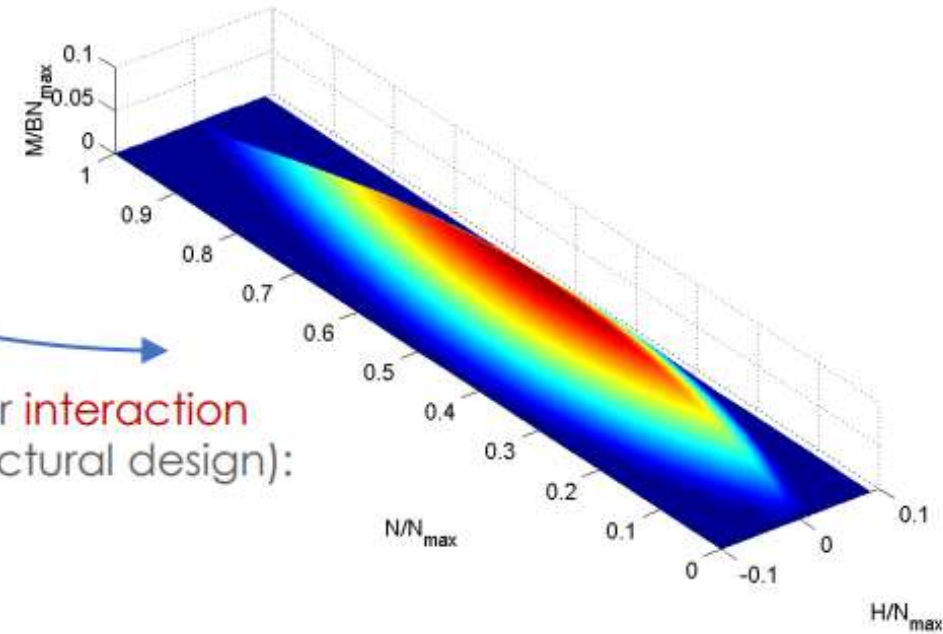

## Annex E (informative) - Seismic bearing capacity of shallow foundations

### Scope

- Use of a **global resistance factor** in the foundation bearing capacity calculations

Dimensionless generalised forces with global resistance factor:

$$\left\{ \begin{array}{l} \bar{N} = \frac{\gamma_R N_{Ed}}{N_{max}} \\ \bar{V} = \frac{\gamma_R V_{Ed}}{N_{max}} \\ \bar{M} = \frac{\gamma_R M_{Ed}}{B N_{max}} \\ \bar{F} = \kappa \frac{\gamma_R \rho a_H B}{\bar{c}} \text{ or } \bar{F} = \kappa \frac{\gamma_R \alpha_H}{\tan \varphi'} \end{array} \right.$$

# 9.5 Pile foundations

## Methods of analysis

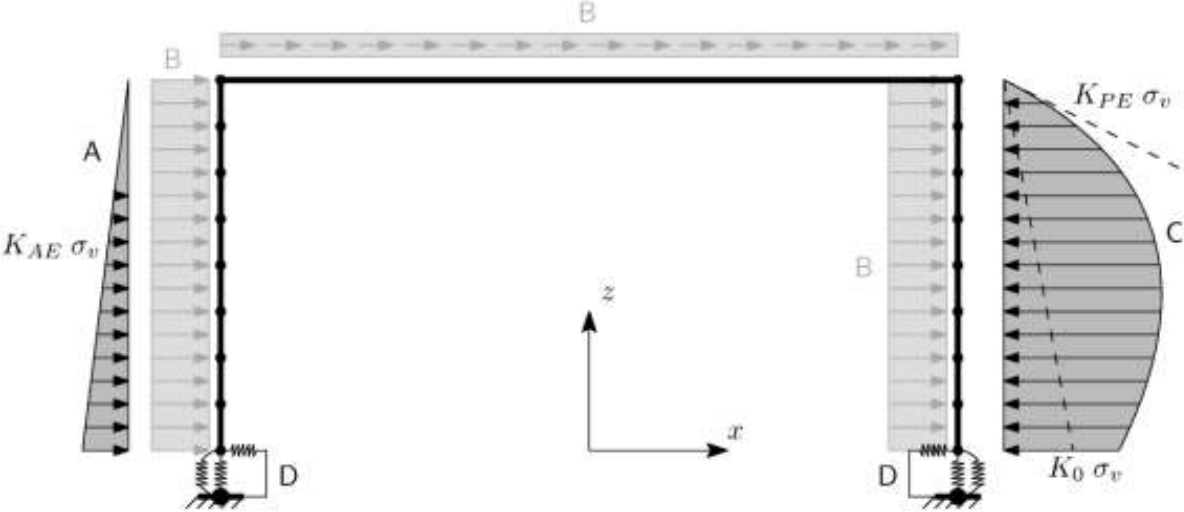

FBA modelling example of integral-abutment bridge (prEN 1998-2:2022)

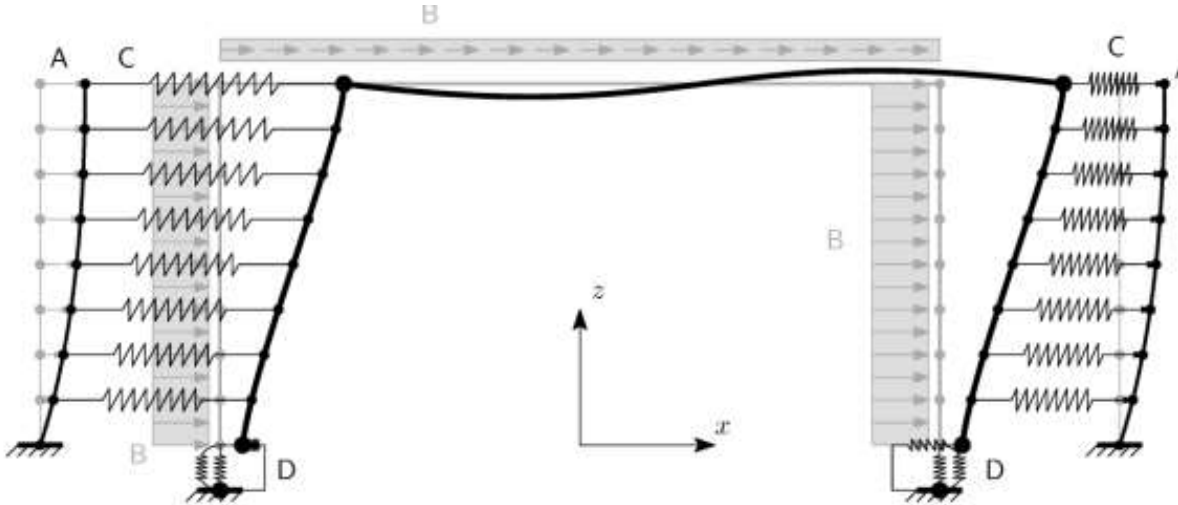

DBA modelling example

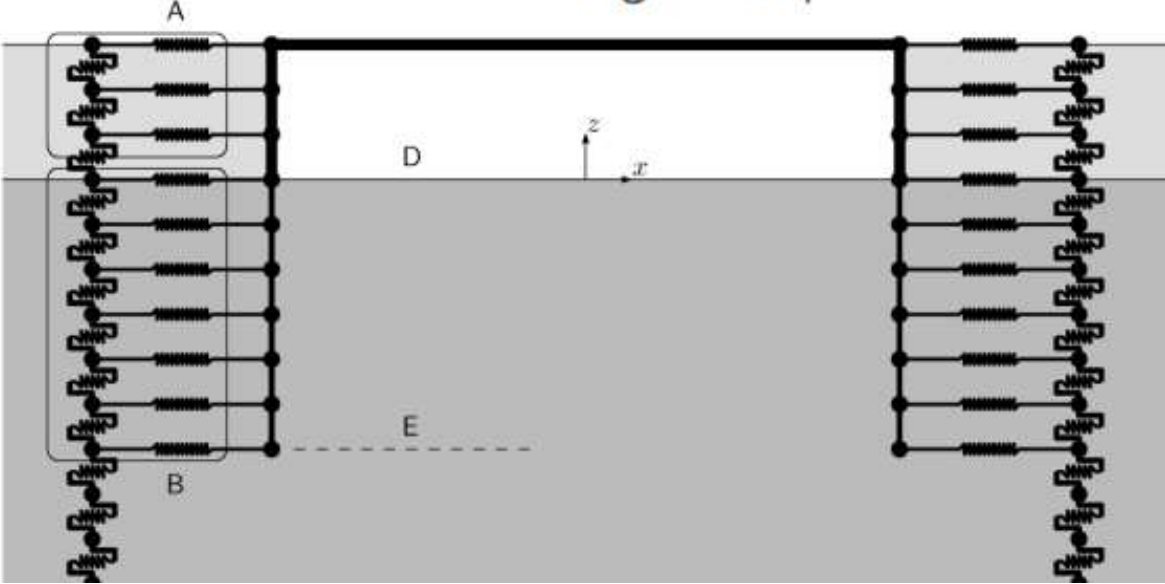

## 9.5 Pile foundations

### Methods of analysis (9.5.3)

#### Group of piles:

And no contribution if minimum pile spacing  $< 6 D$

- Cap base-ground interface strength and stiffness limited to 30% of full contact assumption
- In FBA, limit to 30% of horizontal passive resistance of ground in front of the cap

#### DBA

- Analysis of inertial and kinematic effects to provide maximum displacement of the piles and corresponding curvature demand
- Numerical methods with appropriate boundary conditions and consideration of gapping between the pile and soil (if unfavourable)



## 9.5 Pile foundations

### Design verifications

- **FBA**
    - $N_{Ed} \leq N_{Rd} \rightarrow$  with  $\chi_H = 1,0$
    - $V_{Ed} \leq V_{Rd}$  Lateral bearing capacity with:
- Action effects vs. ultimate ground resistance as in EC7-3

$\chi_H$	1,25	1,5	1,75
Range of permanent displacements (mm)	$\leq 15$	20 to 50	50 to 100

NOTE Values of  $\chi_H$  in Table 9.2 are calibrated for the recommended values of material factors and global resistance factors. Values of  $\chi_H$  for other values of the material factors or global resistance factors are not provided in this standard.

- Earlier seismic codes, including EN 1998-5:2005, demanded that the piles remain structurally elastic after the design earthquake. However:
  - Pile yielding is not as concentrated as in columns above ground, but instead distributed over a much greater length of the pile due to soil confinement. As a result, the plastic hinge rotation is likely small enough to have no detrimental effects
  - Inelastic response of piles may have a beneficial effect on the overall response of the superstructure

# 9.5 Pile foundations

## Methods of analysis

### FBA

- Analysis considering:
  - ✓ bending stiffness of the piles
  - ✓ distribution of ground reactions along the piles
  - ✓ fixity condition at the pile head
  - ✓ pile-group effects (may be significant even if negligible for static case)
- Pile-ground interaction may be represented by independent linear springs (as for static), with ground stiffness consistent with level of deformation
- Lateral deflection:
  - ❖ Small – linear elastic analysis and solutions may be used
  - ❖ Large – non-linear behaviour taken into account

$< \max(0,01D \text{ or } 10 \text{ mm})$

Non-linear independent  $p$ - $y$  and  $t$ - $z$  springs or equivalent-linear strain-dependent springs

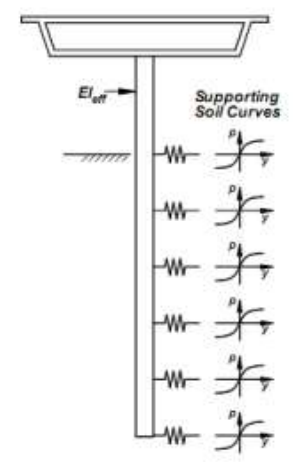

## 9.5 Pile foundations

### Design verifications

- **DBA (non-linear)**

- Displacement demand vs. capacity
- Capacity from plastic hinge strain or rotation limits in pile material
- Two-step verification of yielding piles:
  1. Action effects and resistances expressed either in terms of generalised deformations or in terms of generalised forces. **Critical zones definition** as where  $E_{Fd} \leq R_d$  **in terms of generalized forces**
  2. But, in critical zones, the **verification** should check the **deformation demand against the deformation capacity** of the pile, subjected to the **axial force in the seismic design situation**

## 9.5 Pile foundations

### Methods of analysis

#### FBA

- Analysis of **inertial effects** to provide forces and moments transferred by the superstructure to the top of each pile, the corresponding **deflection and rotation**, and the distribution of **internal forces** along the piles
  - May assume seismic motion only due to vertically propagating shear waves
- Analysis of **kinematic effects** to provide, at least, the bending moments at the pile head and at the interface between layers of different stiffness
  - In pile groups, may be determined considering a single pile in the group

## 9.5 Pile foundations

- Kinematic effects may be neglected:
  - In CC1 structures or
  - For low seismic action class or
  - Stiff and medium ground classes or
  - No strong stiffness contrast in successive layers:
    - ❖ "if the shear wave velocity ratio between two successive layers along the pile length, excluding layers thinner than 3 diameters, does not exceed 2,0 and if the equivalent shear wave velocity in the shallowest five diameters is larger than 150 m/s"
- Battered (inclined) piles should also be designed for residual action effects after the earthquake

## 9.4 Surface and shallow embedded foundations

### Main principle (9.4.2.1.1):

(1) In accordance with the limit state under consideration, footings shall be verified against **sliding failure**, **bearing capacity failure** and **rotational failure**.

### Resisting mechanisms for **sliding**:

- Friction shear at the base ( $v_{Rd,1}$ ), friction shear at vertical sides parallel to seismic action (if cast-in place,  $v_{Rd,2}$ ), and passive earth pressure on vertical sides perpendicular to seismic action (limited in FBA,  $v_{Rd,3}$ )

### Resisting mech. for **bearing capacity**:

- Resisting vertical stresses at the base, and shear and normal forces on vertical sides (if cast-in place) – for vertical force and overturning moments

failure corresponds to unacceptable displ.

## 9.4 Surface and shallow embedded foundations

### Sliding verification:

#### FBA

$$V_{Ed} \leq V_{Rd,1} + V_{Rd,2} + 0,3 V_{Rd,3}$$

$$V_{Rd,1} = F_{Rd} = (N_{Ed} - U) \frac{\tan \delta_f}{\gamma_\delta}$$

Action effects in superstructure without considering sliding

$\chi_H$	1,25	1,5	1,75
Range of permanent displacements (mm)	≤ 15	20 to 50	50 to 100

NOTE Values of  $\chi_H$  in Table 9.1 are calibrated for the recommended values of material factors and global resistance factors. Values of  $\chi_H$  for other values of the material factors or global resistance factors are not provided in this standard.

#### DBA (non-linear)

- Sliding accepted at SD or NC
  - ❖ If acceptable for the superstructure and lifelines
- $\chi_H = 1,0$
- Full  $V_{Rd,3}$  may be activated

# EC8-5-10 EARTH RETAINING STRUCTURES

## 1. introduction

**displacing** vs **non- displacing** structures  
**force-based** vs **displacement-based** approach

## 2. force-based

- displacing
- non- displacing
- specific cases

verifications (displacements, internal forces)  
**capacity** / **demand**

verifications (displacements, internal forces)  
**capacity**/ **demand**

anchored, gravity, walls on piles  
(not covered today)

## 3. displacement-based

**coupled** vs **uncoupled** calculation models



NOTE The expressions "displacing retaining structures" and "non-displacing retaining structures" refer to systems that respectively can or cannot experience residual seismic displacements.

accumulate displacement

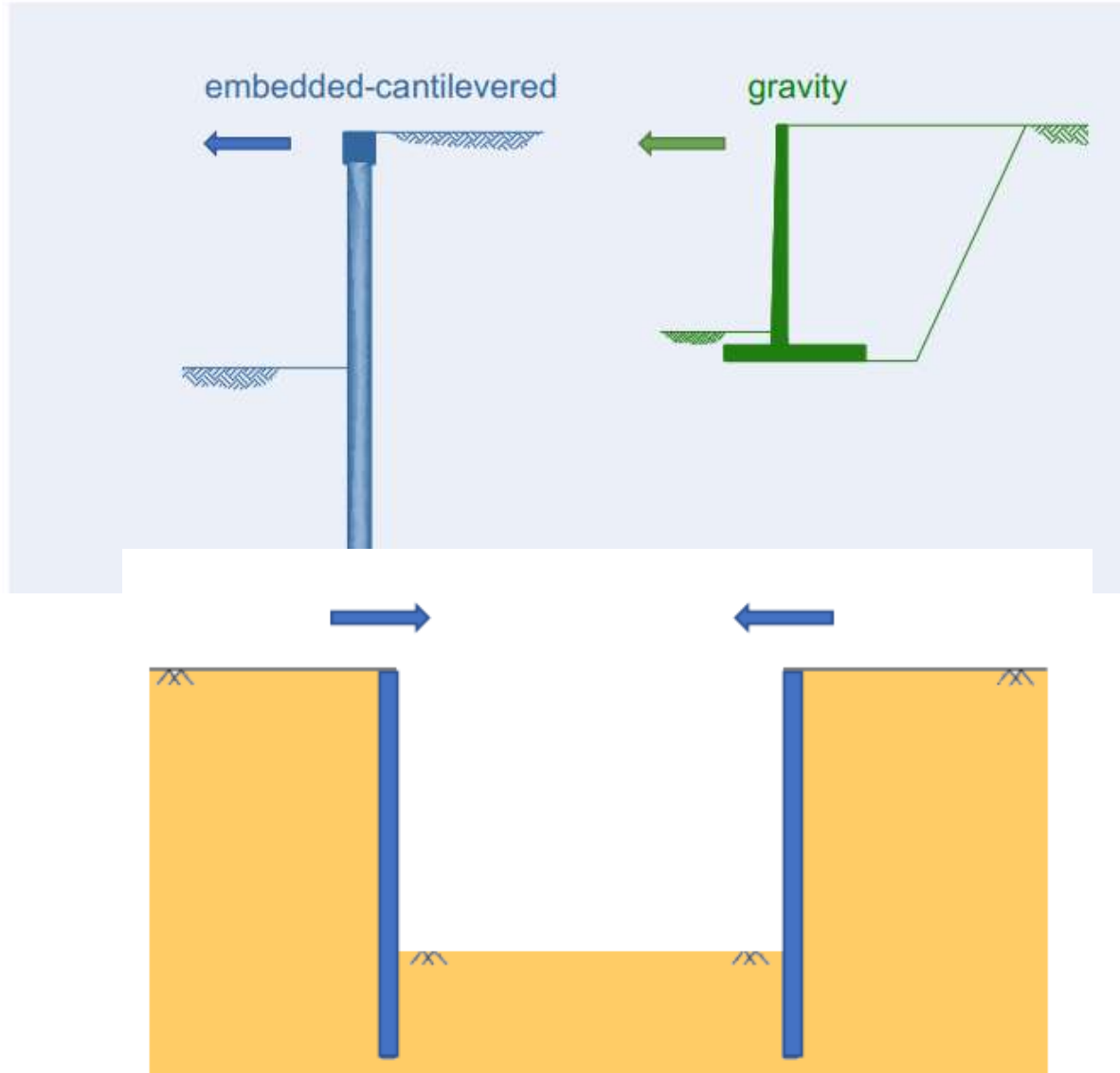

does not accumulate displacement

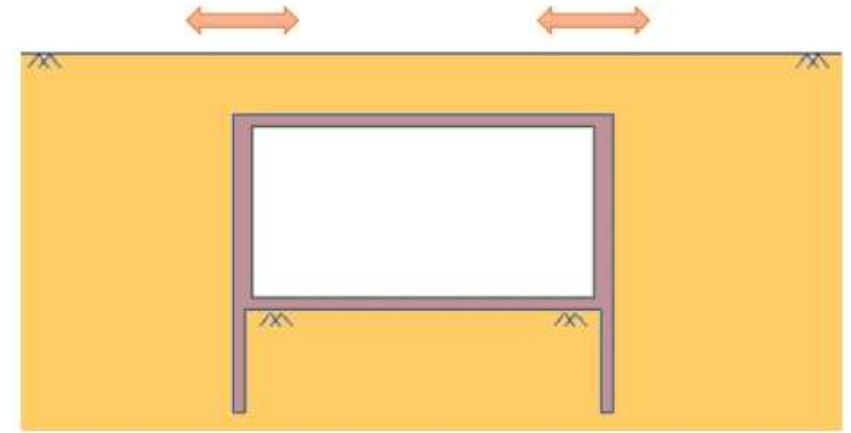

- (5) The seismic performance of a retaining structure should be expressed by a) and b):
- a) a measure of its residual displacement for the limit state under consideration;
  - b) the capacity/demand ratio for the structural members.

force – based

→

- action: elastic spectrum (or PGA)
- displacement related to equivalent seismic actions
- forces in structural members from calculation model

displacement – based

→

- action: (mostly) time histories
- explicit calculation of displacements
- forces in structural members: direct or indirect

## displacing retaining structures

force – based approach → compare **capacity** and **demand**

**capacity**: critical seismic coefficient  $\alpha_C$   
(**actual** seismic resistance)

**demand**: equivalent seismic coefficient  $\alpha_H$   
(**equivalent** seismic action)

$$\alpha_H = \frac{1}{g} \frac{\beta_H}{\chi_H} \frac{S_\alpha}{F_A}$$

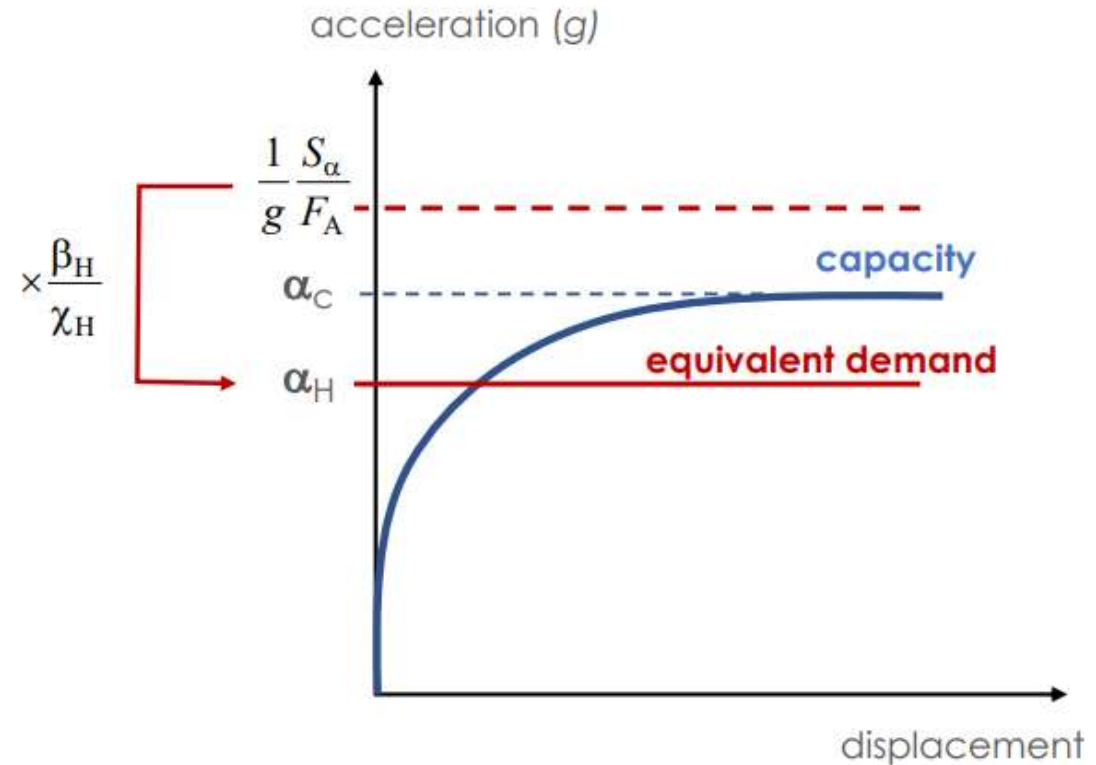
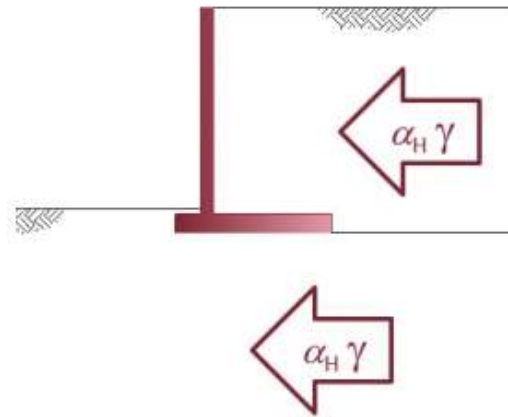

# displacing retaining structures

**capacity:** critical seismic coefficient  $\alpha_c$

study of a plastic mechanism

- equilibrium (total stresses)
- strength (effective stresses)

- (4) The design resistance (seismic capacity) should be expressed by the critical seismic coefficient  $\alpha_c$ , defined as the minimum horizontal seismic coefficient that leads to failure of the geotechnical structure in a pseudo-static analysis.
- (5) The critical seismic coefficient  $\alpha_c$  should be calculated considering the equilibrium of the retaining structure and assuming that the strength of the ground volume interacting with the structure is fully mobilised.
- (6) To apply (5), the soil strength should be expressed in terms of effective stresses, considering explicitly, where appropriate, the effect of pore water pressure.
- (7) To apply (5), equilibrium Formulas should consider total stresses (i.e. effective stresses plus pore water pressures) at the structure-ground contact surfaces and the body forces in the retaining structure deriving from gravity and from the seismic action, where applicable in accordance with 10.3.1(1).

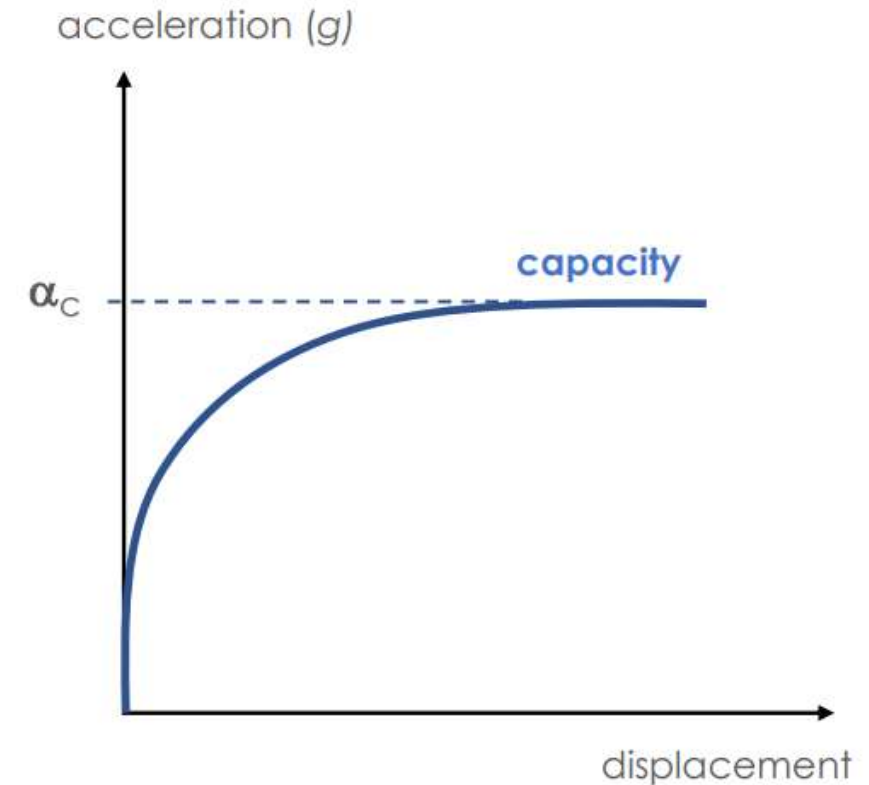
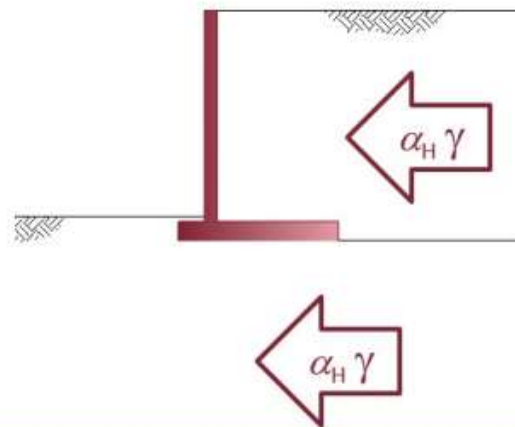

**capacity:** critical seismic coefficient  $\alpha_c$

- found by iteration (hand calculations or numerical analyses)
- characterises the **weakest plastic mechanism**

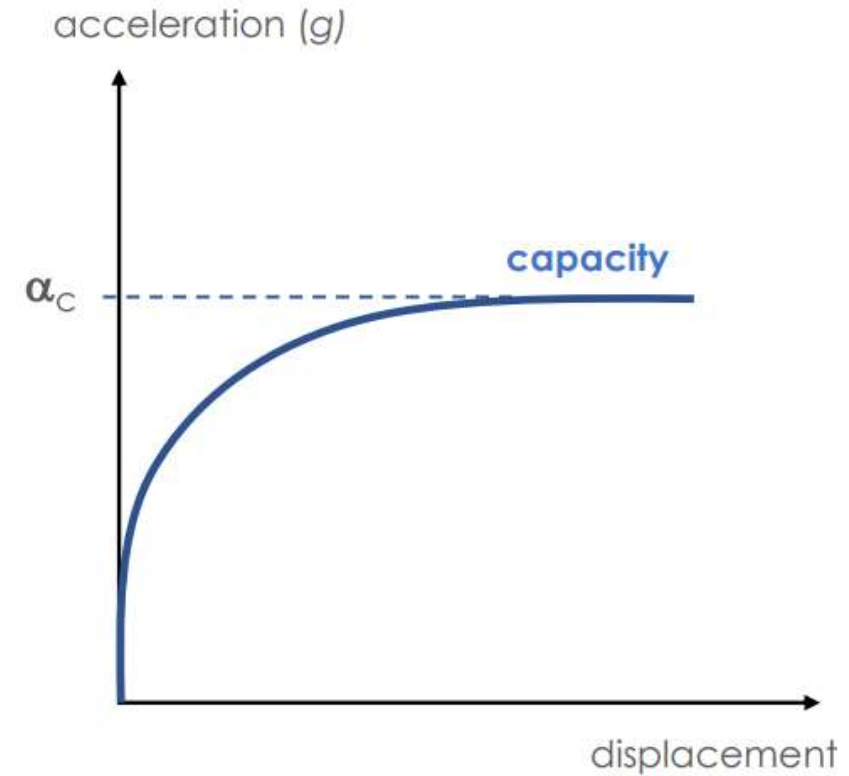
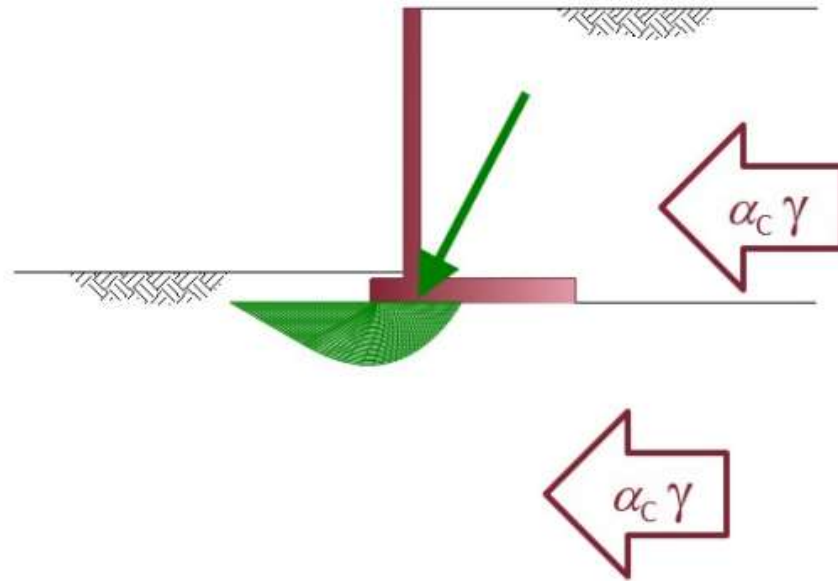
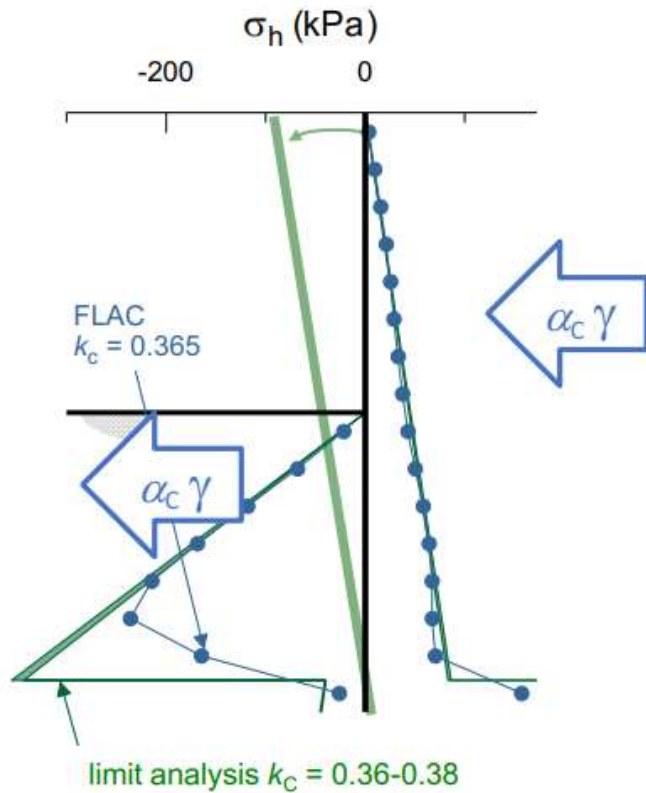

## drainage conditions and effect of pore water pressure

- (6) To apply **(5)**, the soil strength should be expressed in terms of effective stresses, considering explicitly, where appropriate, the effect of pore water pressure.

### effective stress analysis – why?

- excess pore water pressures produced by construction are no longer there (steady-state initial conditions)
- undrained shear strength from site investigation not applicable (too large)
- solutions in terms of total stresses not robust

$$\sigma_a = \sigma'_a + u = -2c' \sqrt{K_{AE}} + K_{AE} (\sigma_v - u) + u$$

$$\sigma_p = \sigma'_p + u = 2c' \sqrt{K_{PE}} + K_{PE} (\sigma_v - u) + u$$

$u$  includes excess p.w.p. produced by the earthquake, where applicable

\* guidance on  $K_{AE}$ ,  $K_{PE}$  in Annex F

but pore pressure  $u$  has an additional effect...

$$\theta_{eq} = A \tan(\alpha_H) \quad \text{in the absence of pore water pressure} \quad (10.3)$$

$$\theta_{eq} = A \tan\left(\alpha_H \frac{\sigma_v}{\sigma_v - u}\right) \quad \text{in the presence of pore water pressure} \quad (10.4)$$

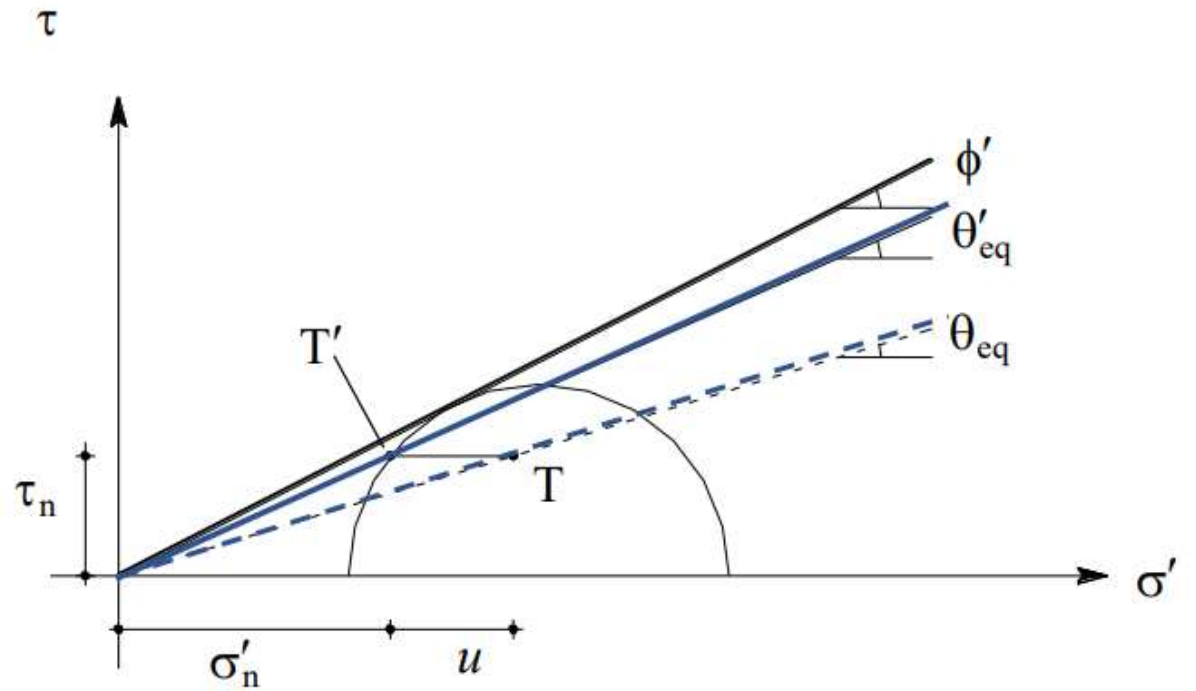
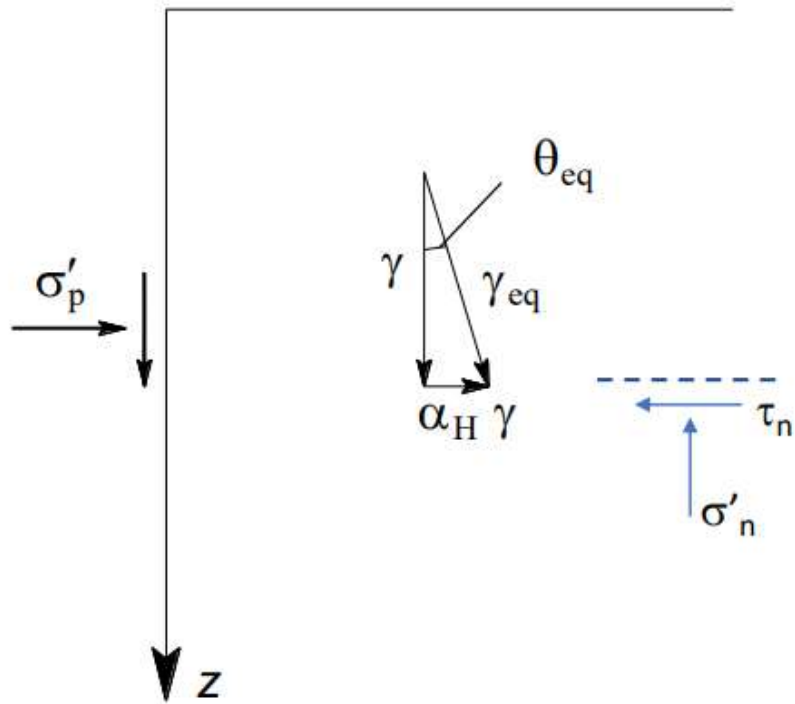

but pore pressure  $u$  has an additional effect...

$$\theta_{eq} = \text{Atan}(\alpha_H) \quad \text{in the absence of pore water pressure} \quad (10.3)$$

$$\theta_{eq} = \text{Atan}\left(\alpha_H \frac{\sigma_v}{\sigma_v - u}\right) \quad \text{in the presence of pore water pressure} \quad (10.4)$$

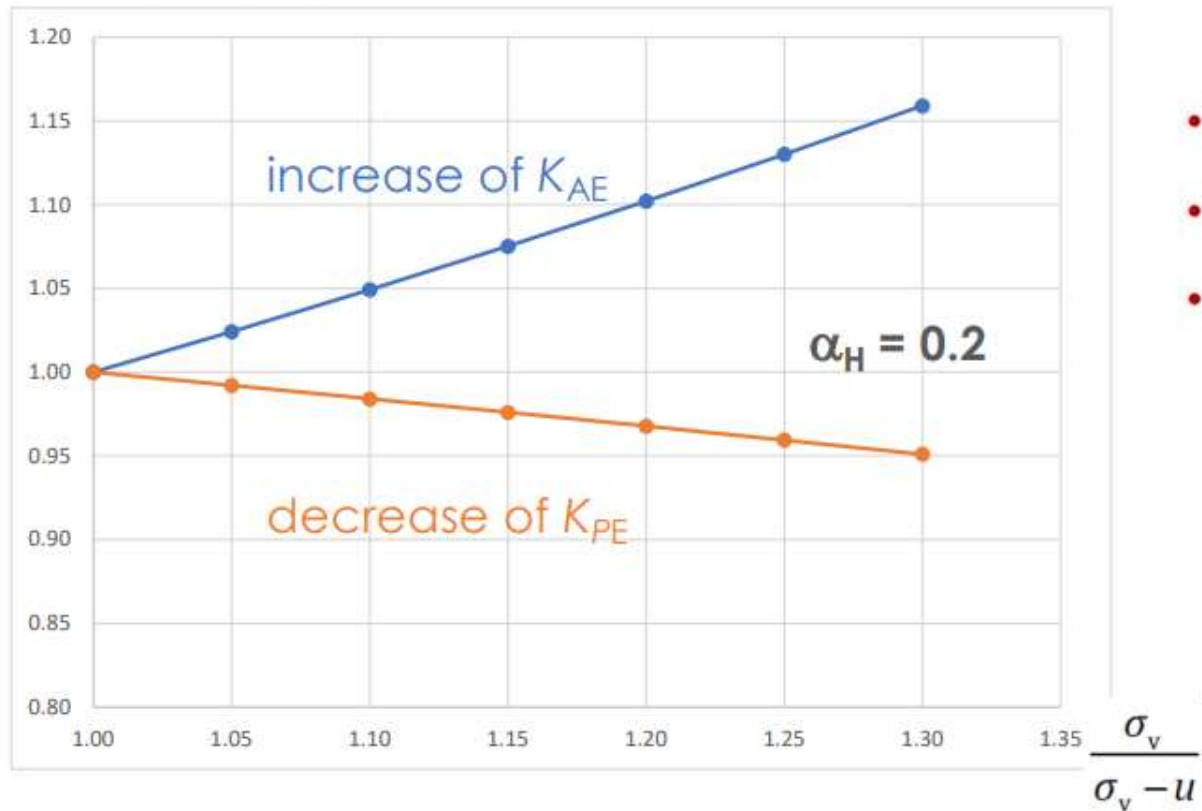

- quasi-linear variation with  $\sigma_v/\sigma'_v$
- little dependence on  $\phi'$ ,  $\delta$
- strong dependence on  $\alpha_H$



# calculation of capacity: an example

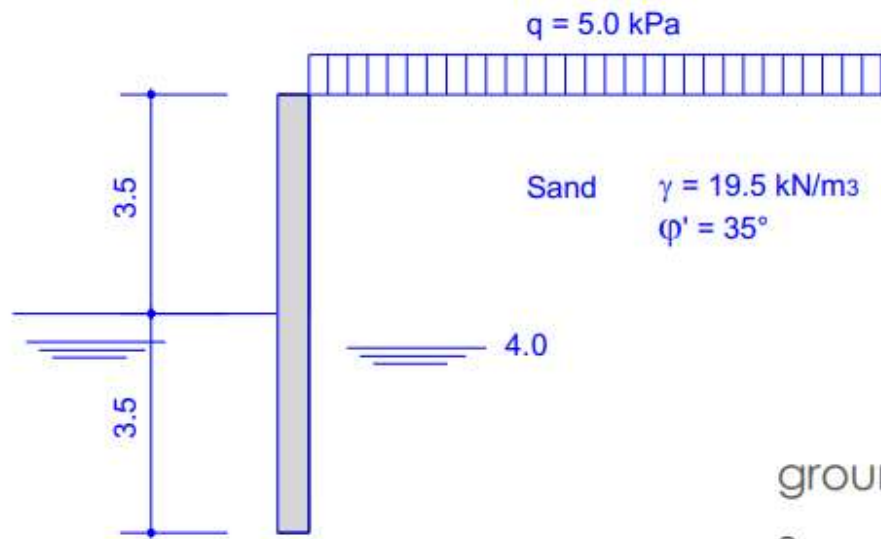

ground category E

$$S_{\alpha 475} = 0.3 \text{ g}$$

$$F_T = 1 \quad F_\alpha = 1.87 \quad F_\beta = 2.24$$

$$S_\alpha = 0.3 \times 1.87 = 0.56 \text{ g}$$

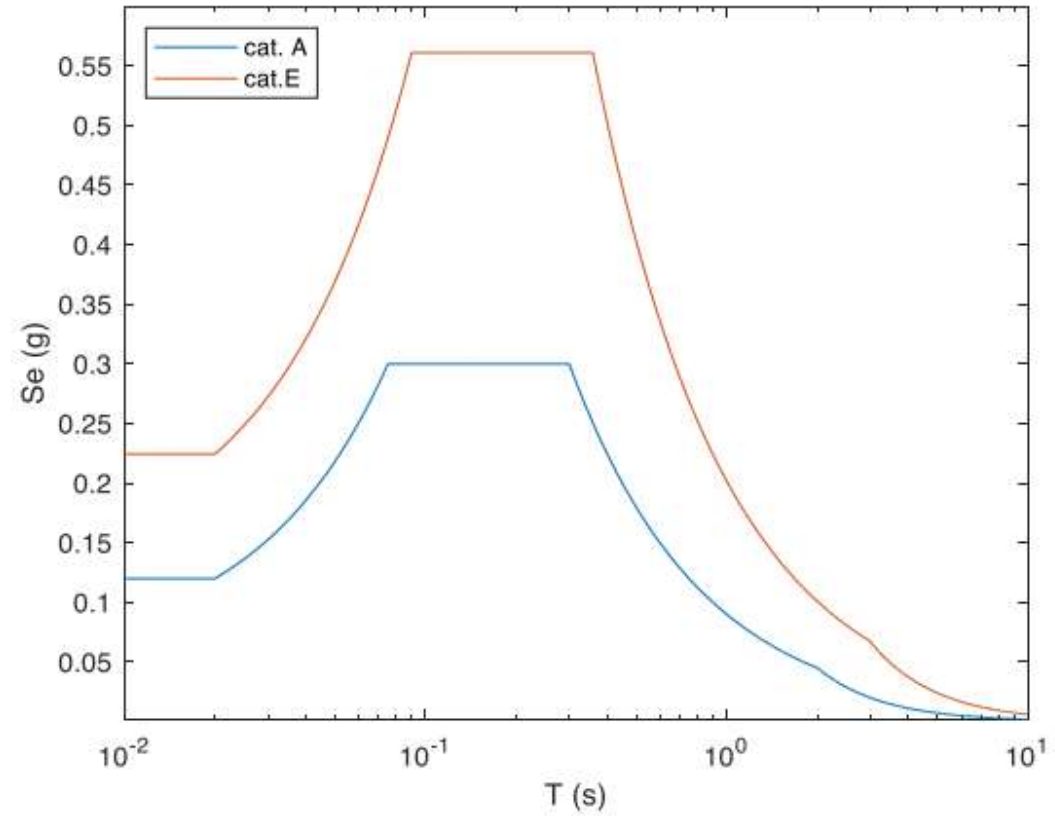

Project: Embedded retaining wall

Soil prop	$\gamma$	c'k	c'd	$\phi'_k$	$\phi'_d$	$\phi'_d$	scabr	$\delta$	$\delta$
	(kN/m <sup>3</sup> )			(°)	rad	rad		(°)	rad
sand	19.5	0	0	34	34.00	0.59	0.67	24.2	0.42

Exc. Height 3.5 m  
 Wall length 7.0 m  
 water table 4.0 m  
 Rot. point OK 6.00 m

incl. p.c.  
 0.0  
 0.0

$\gamma_w$  1.000  
 $\gamma_o$  1.000  
 surcharge 5.0 kPa

layer	point	z (m)	$\gamma$ (kN/m <sup>3</sup> )	$\sigma_v$ (kPa)	u (kPa)	$\sigma'_v$ (kPa)	$\sigma_v/\sigma'_v$	$\theta'$	teta-a/p L	Ka/Kp	$\sigma'_{ha/p}$ (kPa)	$\sigma_{ha/p}$ (kPa)	S (kN/m)	dist from toe (m)	M (kNm/m)	$\Delta u$ (kPa)
1	A	0.0	19.5	5.0	0.0	5.0	1.0	0.000	0.200	0.237	1.2	1.2				
1	B	4.0	19.5	83.0	0.0	83.0	1.0	0.000	0.200	0.237	19.7	19.7	41.79	4.41	184.25	
1	B	4.0	19.5	83.0	0.0	83.0	1.0	0.000	0.200	0.237	19.7	19.7	63.64	1.87	119.20	0.0
2	P	6.00	19.5	122.0	19.6	102.4	1.2	0.000	0.200	0.237	24.3	43.9	688.80	0.49	338.58	0.0

Parametri Risolutore

Imposta obiettivo:

A:  Max  Min  Valore di:

Modificando le celle variabili:

Soggette ai vincoli:

Aggiungi

15.10	3.17	47.82	
260.49	1.82	474.41	
32.59	0.47	15.29	
794.22		642.03	
308.18		537.52	
0.39		0.84	
$\alpha_c$		0.000	
$\theta_{eq}$		0.000	

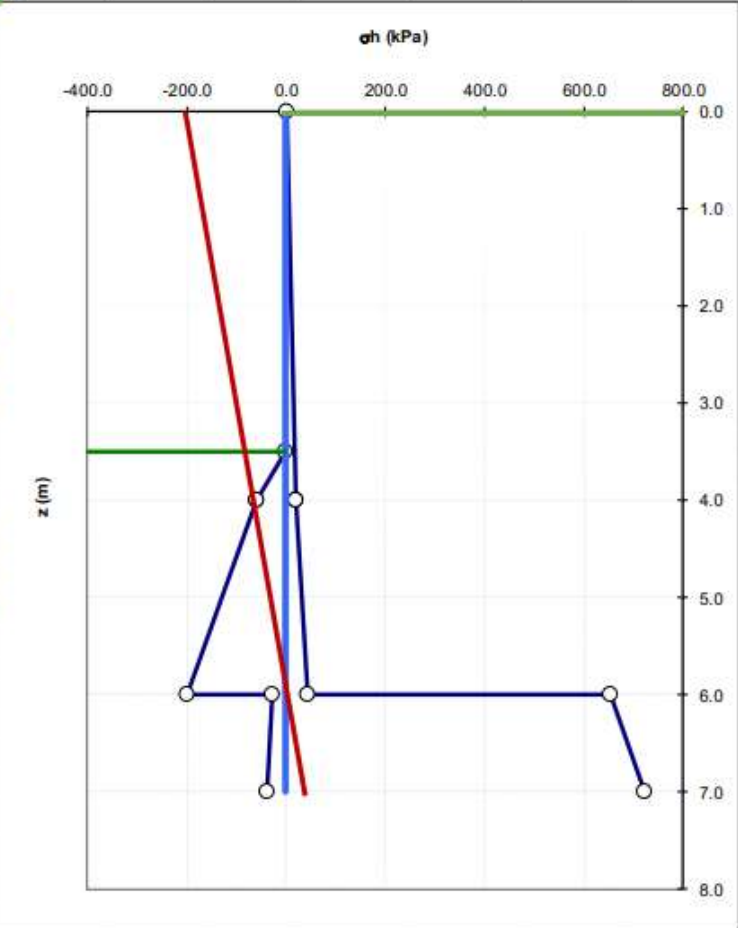

Project: Embedded retaining wall

Soil prop	$\gamma$	$c^k$	$c^d$	$\phi_k$	$\phi_d$	$\phi_u$	scabr	$\delta$	$\delta$
	(kN/m <sup>3</sup> )			(°)	(°)	rad		(°)	rad
sand	19.5	0	0	34	34.00	0.59	0.67	24.2	0.42

Exc. Height	3.5 m
Wall length	7.0 m
water table	4.0 m
Rot. point	OK 6.73 m

incl. p.c.	0.0
	0.0

$\gamma_{ep}$	1.000	surcharge	5.0 kPa
$\gamma_o$	1.000		

layer	point	z (m)	$\gamma$ (kN/m <sup>3</sup> )	$\sigma_v$ (kPa)	u (kPa)	$\sigma'_v$ (kPa)	$\sigma'_v/\sigma_v$	$\theta'$	teta-a/p L	Ka/Kp	$\sigma'_{ha/p}$ (kPa)	$\sigma_{ha/p}$ (kPa)	S (kN/m)	dist from toe (m)	M (kNm/m)	$\Delta u$ (kPa)
1 A		0.0	19.5	5.0	0.0	5.0	1.0	0.204	-0.087	0.371	1.9	1.9				
1 B		4.0	19.5	83.0	0.0	83.0	1.0	0.204	-0.087	0.371	30.8	30.8	65.37	4.41	288.22	
1 B		4.0	19.5	83.0	0.0	83.0	1.0	0.204	-0.087	0.371	30.8	30.8				0.0
2 P		6.73	19.5	136.2	26.8	109.4	1.2	0.252	-0.157	0.422	46.1	72.9	141.58	1.45	205.39	0.0
2 P		6.73	19.5	136.2	26.8	109.4	1.2	0.252	0.518	5.229	572.3	599.1				0.0
2 D		7.0	19.5	141.5	29.4	112.1	1.3	0.256	0.516	5.213	584.3	613.7	164.07	0.13	22.11	0.0
1 D		3.5	19.5	0.0	0.0	0.0	1.0	0.204	0.540	5.440	0.0	0.0				
1 E		4.0	19.5	9.8	0.0	9.8	1.0	0.204	0.540	5.440	53.0	53.0	13.26	3.17	41.99	
2 E		4.0	19.5	9.8	0.0	9.8	1.0	0.204	0.540	5.440	53.0	53.0				0.0
2 P		6.73	19.5	63.0	26.8	36.2	1.7	0.346	0.470	4.763	172.4	199.2	344.20	1.37	472.13	0.0
2 P		6.73	19.5	63.0	26.8	36.2	1.7	0.346	-0.298	0.556	20.1	46.9				0.0
2 F		7.0	19.5	68.3	29.4	38.8	1.8	0.349	-0.303	0.562	21.8	51.3	13.28	0.13	1.77	0.0

back	371.02	515.72
front	370.74	515.89
ratios	1.00	1.00

capacity:  $\alpha_c = 0.207$

$\alpha_c$	0.207
$\theta_{eq}$	0.204

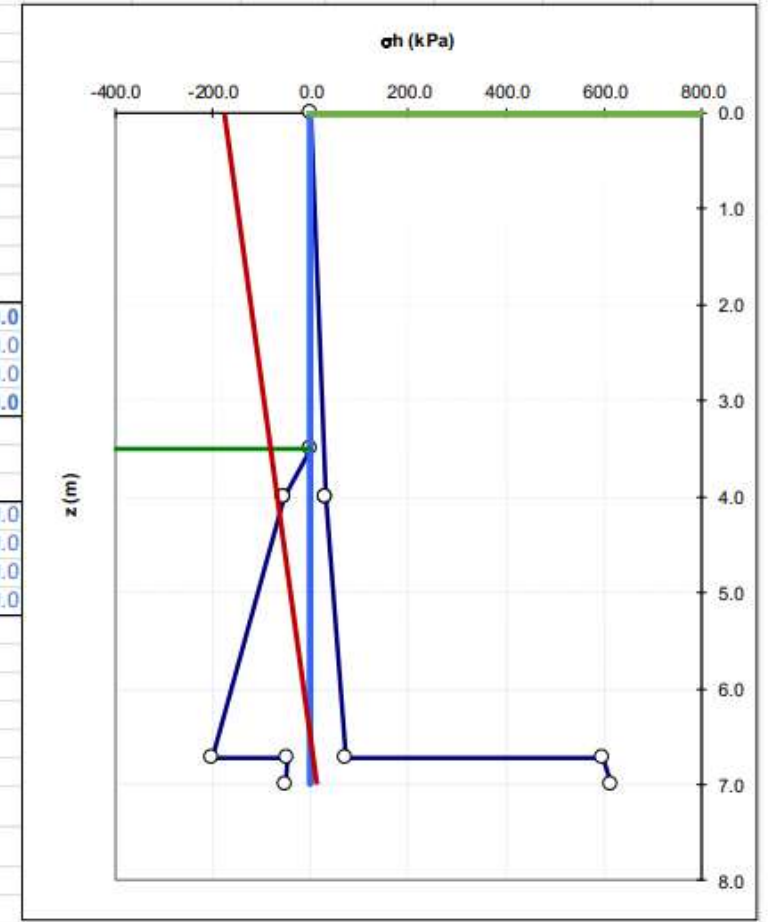

**demand:** equivalent seismic coefficient  $\alpha_H$

$$\alpha_H = \frac{1}{g} \frac{\beta_H}{\chi_H} \frac{S_\alpha}{F_A}$$

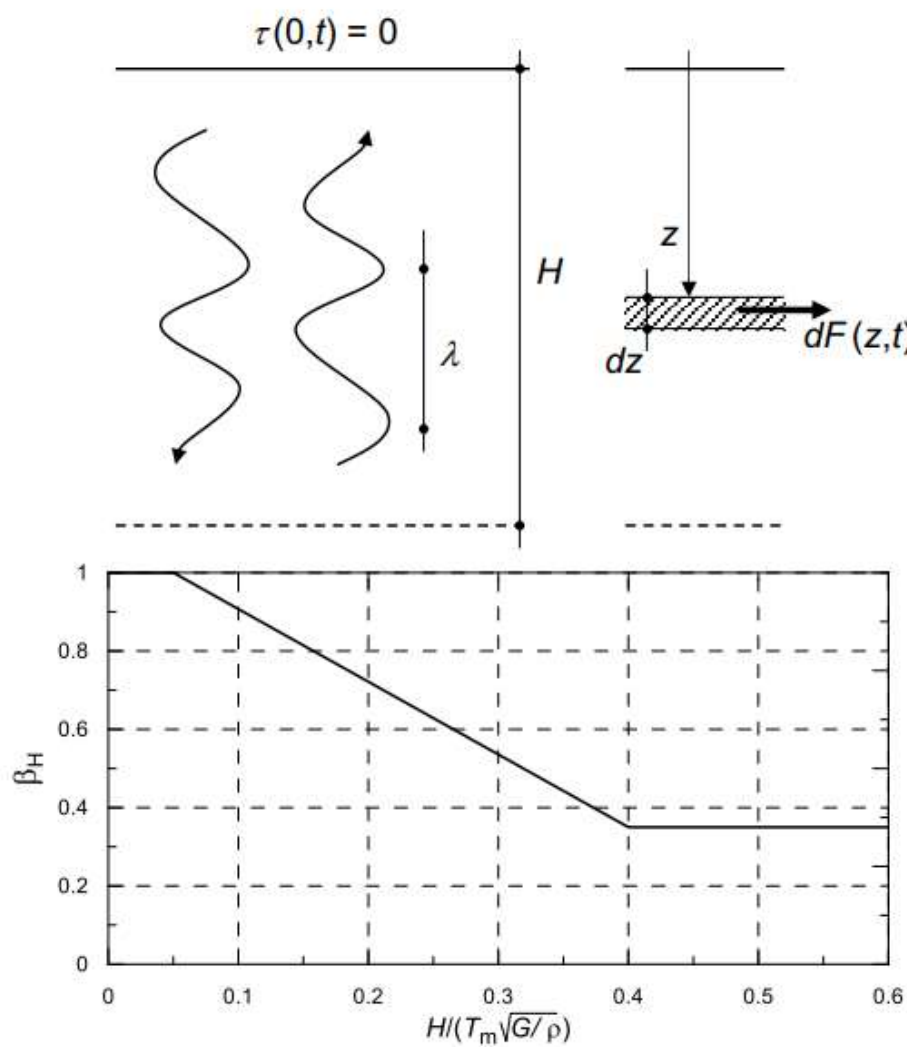

$$T_m \sqrt{\frac{G}{\rho}} \approx \lambda$$

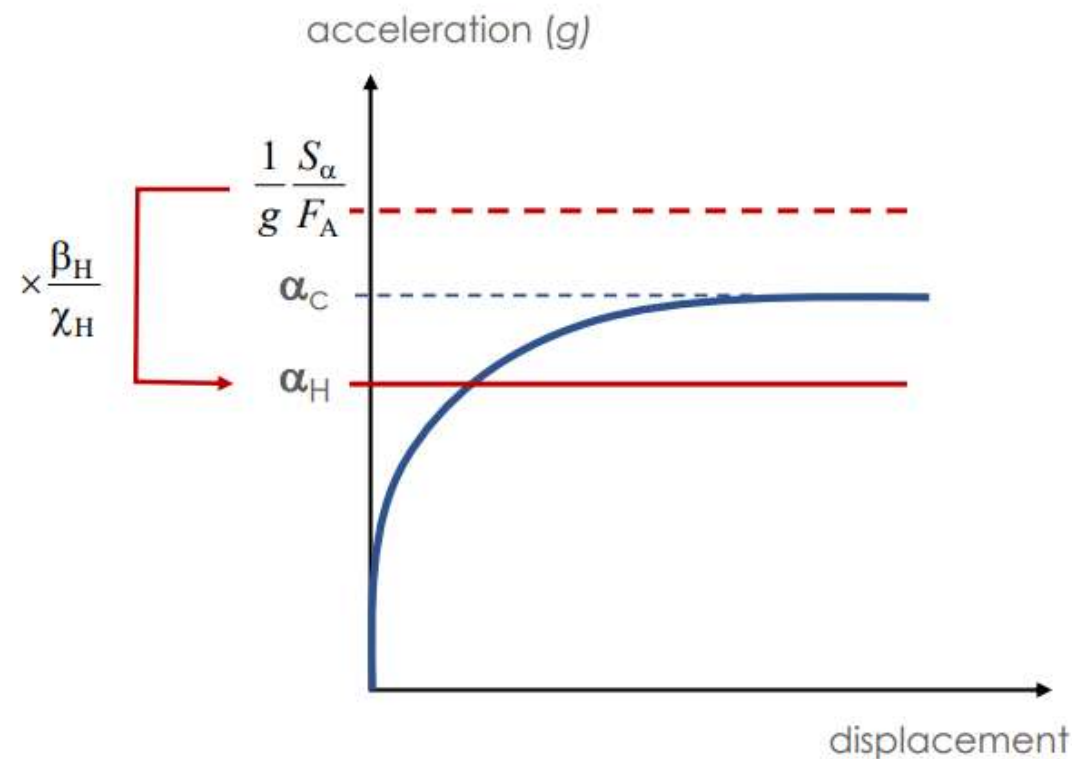

**demand:** equivalent seismic coefficient  $\alpha_H$

$$\alpha_H = \frac{1}{g} \frac{\beta_H}{\chi_H} \frac{S_\alpha}{F_A}$$

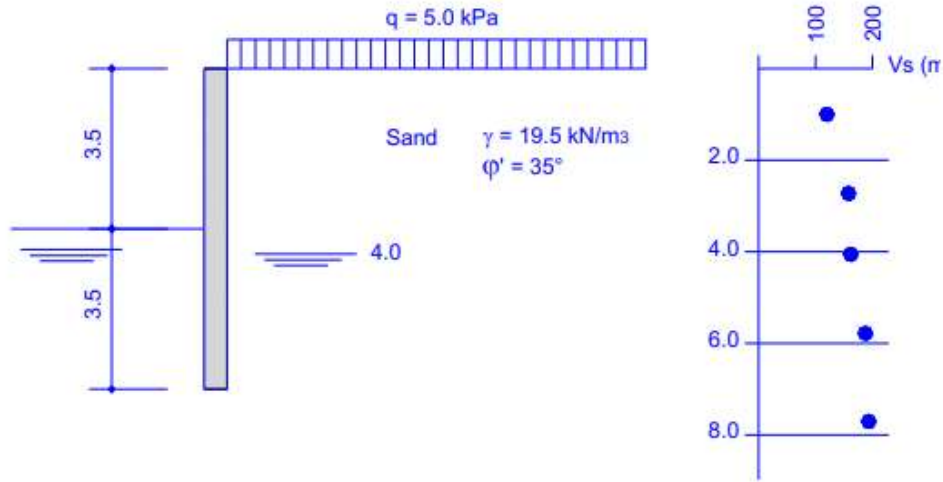

**Table 6.1 ·**

Seismicity level	150 ≤ v <sub>s</sub> < 250 m/s	
	G/G <sub>0</sub>	ζ
EN 1998-1_1:2021, Table 5.2		
Very low	0,70 (±0,08)	0,04
Low	0,50 (±0,14)	0,07
Moderate	0,30 (±0,1)	0,10
High	0,20 (±0,10)	0,20

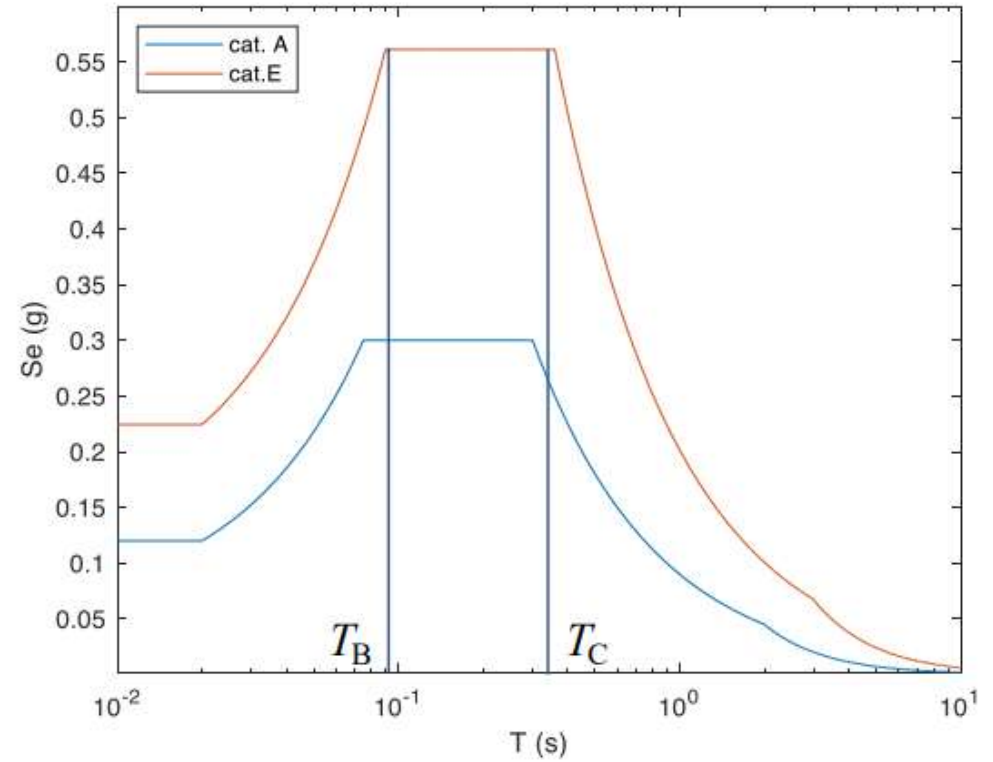

$$T_B = 0.09 \text{ s}$$

$$T_C = 0.36 \text{ s}$$

$$G_0 = 64.4 \text{ MPa}$$

$$G = 0.4 \times G_0 = 25.8 \text{ MPa}$$

$$\lambda \approx (T_B + T_C) \sqrt{\frac{G}{\rho}} = 51 \text{ m}$$

$$\frac{H}{\lambda} = 0.10 \Rightarrow \beta_H = 0.9$$

**demand:** equivalent seismic coefficient  $\alpha_H$

$$\alpha_H = \frac{1}{g} \frac{\beta_H}{\chi_H} \frac{S_\alpha}{F_A} \quad \rightarrow \quad \frac{1}{\chi_H} = \frac{a_H}{\beta_H a_{\max}} = \frac{a_H}{a_{\max\_eq}}$$

displacement

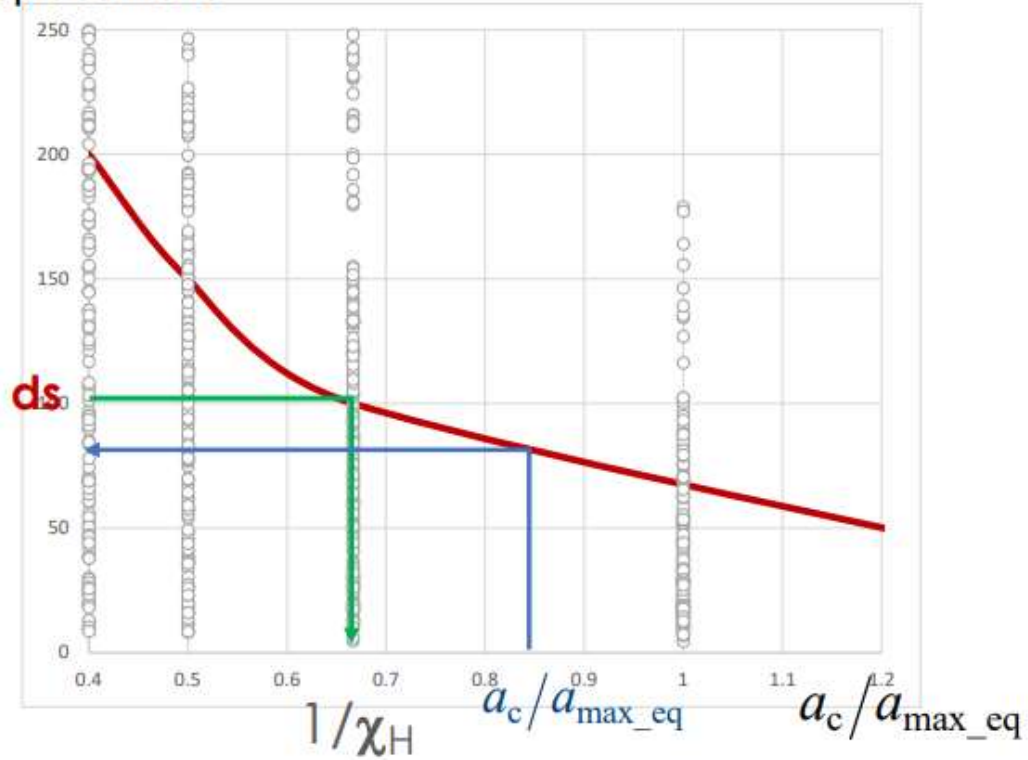

acceleration (g)

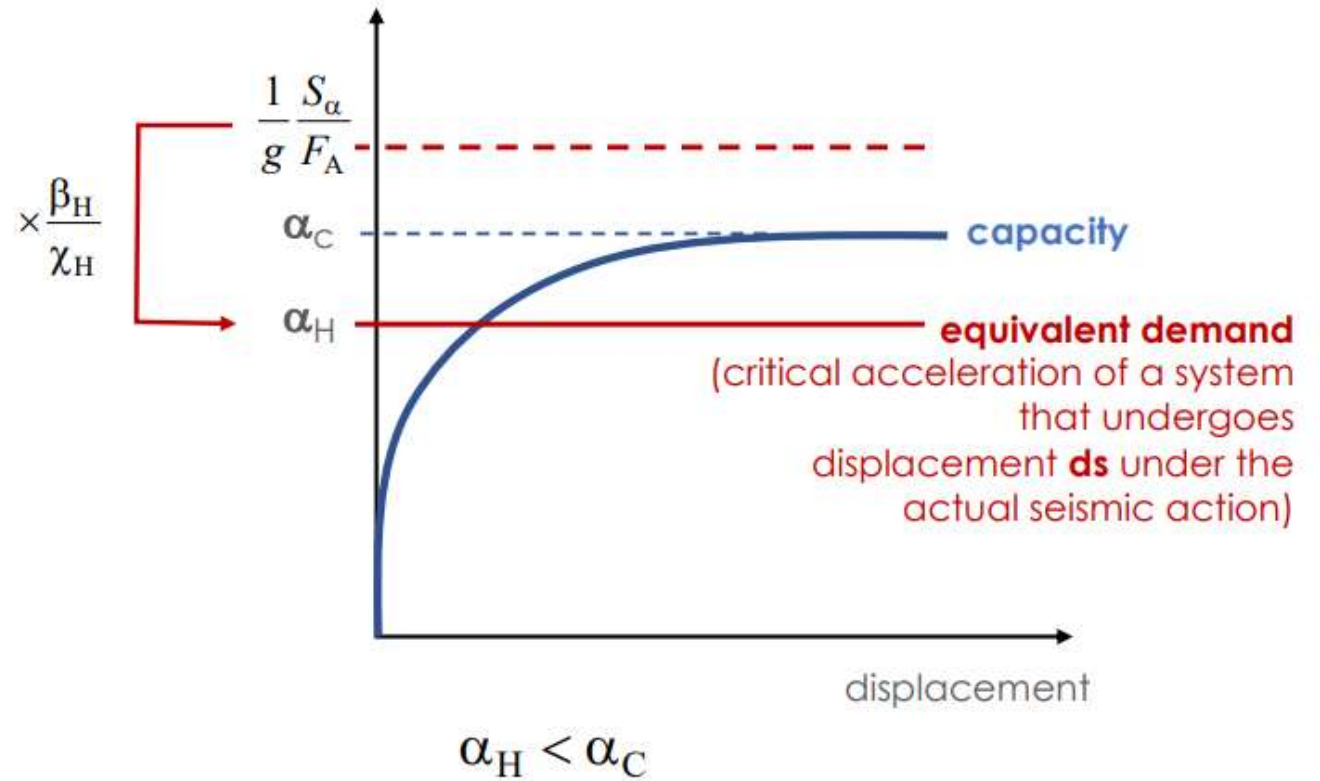

**Table 10.1 – Values of  $\chi_H$  for retaining structures**

$\chi_H$ for gravity retaining structure	1,5	2,0	2,5
$\chi_H$ for embedded retaining structure	1,0	1,5	2,0
Range of displacement (mm)	30-100	40-150	50-200

- (3) Values of  $\chi_H$  smaller than those given in Table 10.1 may be used to ensure lower residual displacements.

NOTE To comply with **(3)**, it can be necessary to calculate the design action effects using values of  $\chi_H < 1$ . However,  $\chi_H$  needs not be smaller than 0,6.

to design for negligible displacement ( $< 10$  mm) use  $\chi \approx 0.6 \rightarrow a_c \approx 1.7 a_{max}$

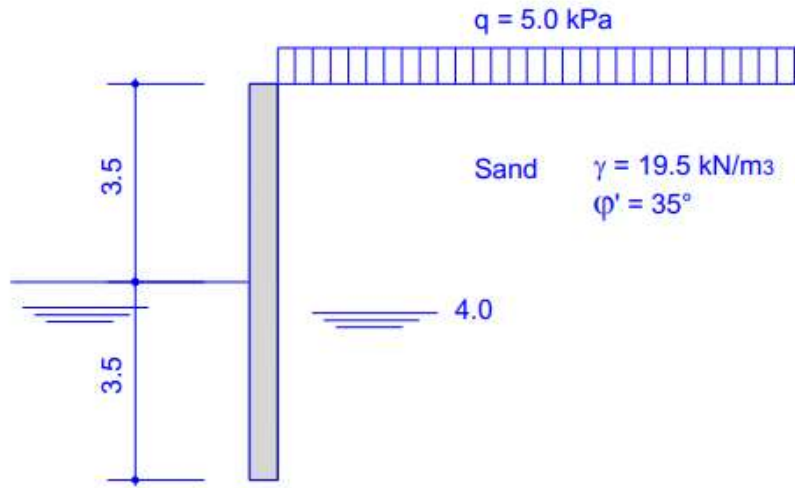

capacity:  $\alpha_C = 0.207$

$$\alpha_H = \frac{1}{g} \frac{\beta_H}{\chi_H} \frac{S_\alpha}{F_A} = \frac{0.9}{1.0} \times \frac{0.56}{2.5} = 0.20$$

$$\chi_H = 1.0 \rightarrow \alpha_H = 0.196$$

demand:  $\alpha_H = 0.20$

$$S_\alpha = 0.3 \times 1.87 = 0.56 \text{ g}$$

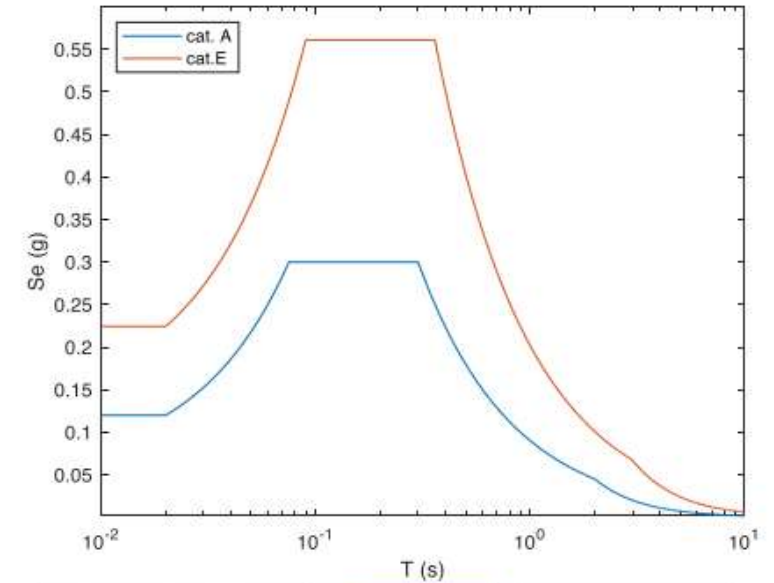

$\chi_H$ for embedded retaining structure	1,0	1,5
Range of displacement (mm)	30-100	40-150



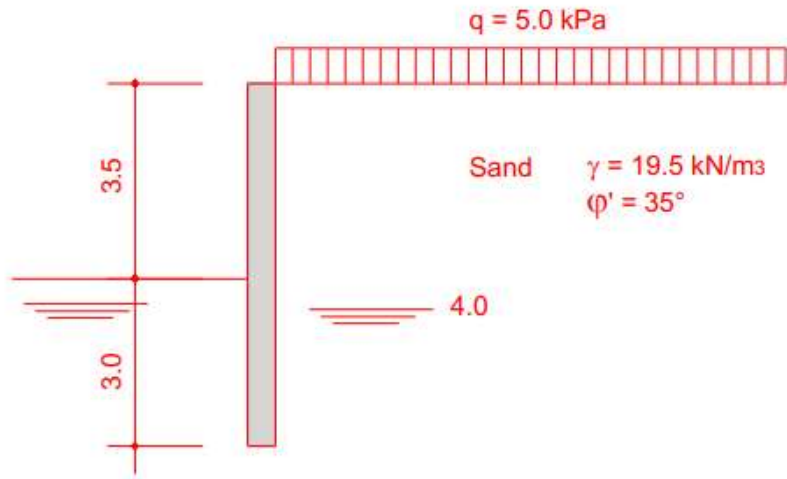

capacity:  $\alpha_C = 0.15$

$$\alpha_H = \frac{1}{g} \frac{\beta_H}{\chi_H} \frac{S_\alpha}{F_A} = \frac{0.9}{1.5} \times \frac{0.56}{2.5} = 0.13$$

$\chi_H = 1.5 \rightarrow \alpha_H = 0.134$

demand:  $\alpha_H = 0.13$

$$S_\alpha = 0.3 \times 1.87 = 0.56 \text{ g}$$

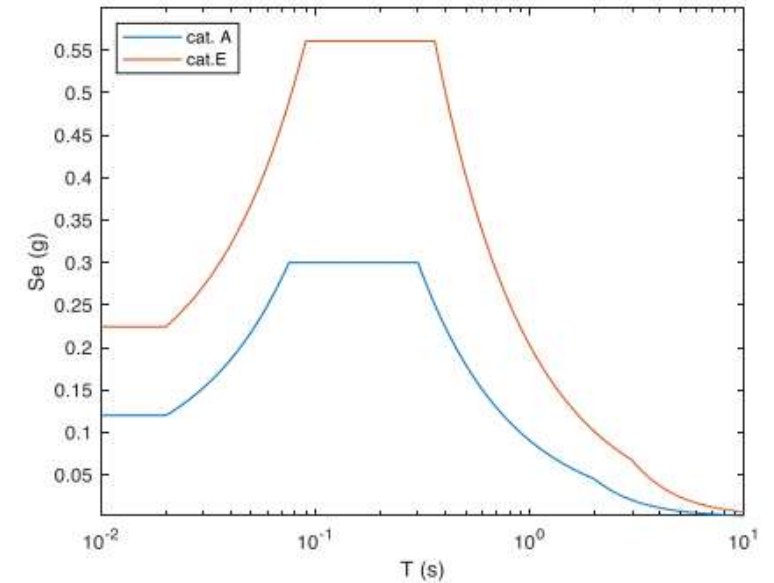

$\chi_H$ for embedded retaining structure	1,0	1,5
Range of displacement (mm)	30-100	40-150

## displacing retaining structures

force – based approach → compare **capacity** and **demand**

(5) The seismic performance of a retaining structure should be expressed by a) and b):

a) a measure of its residual displacement for the limit state under consideration;

b) the capacity/demand ratio for the structural members.

**capacity**: resistance of structural members

**demand**: internal forces

- **computed assuming**  $\alpha_H = \alpha_C$  (or  $\alpha_H = \text{PGA}/g$  if no displacement)
- **multiplied by**  $\gamma_{Rd} = 1.2$

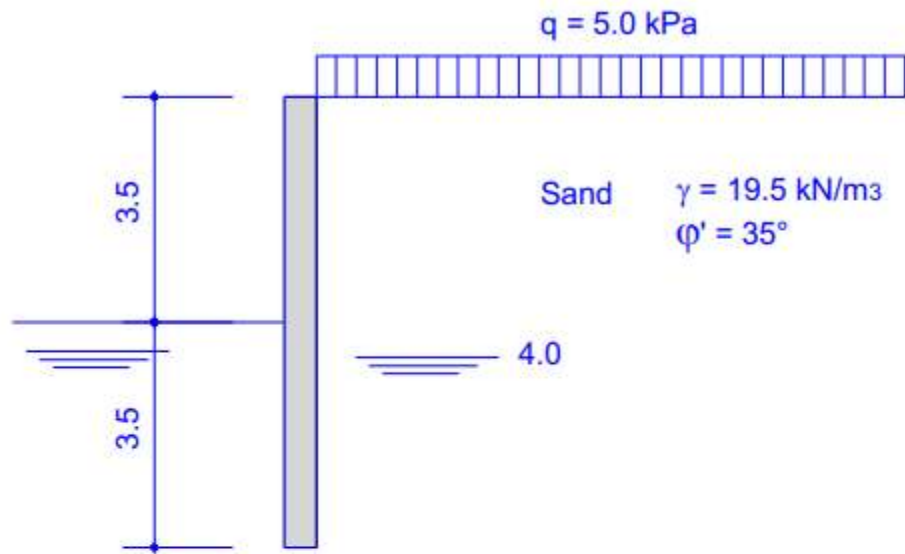

capacity:  $\alpha_C = 0.207$

$$M_{\max} = 126 \text{ kNm/m}$$

$$M_d = 1.2 \times 126 = \mathbf{151 \text{ kNm/m}}$$

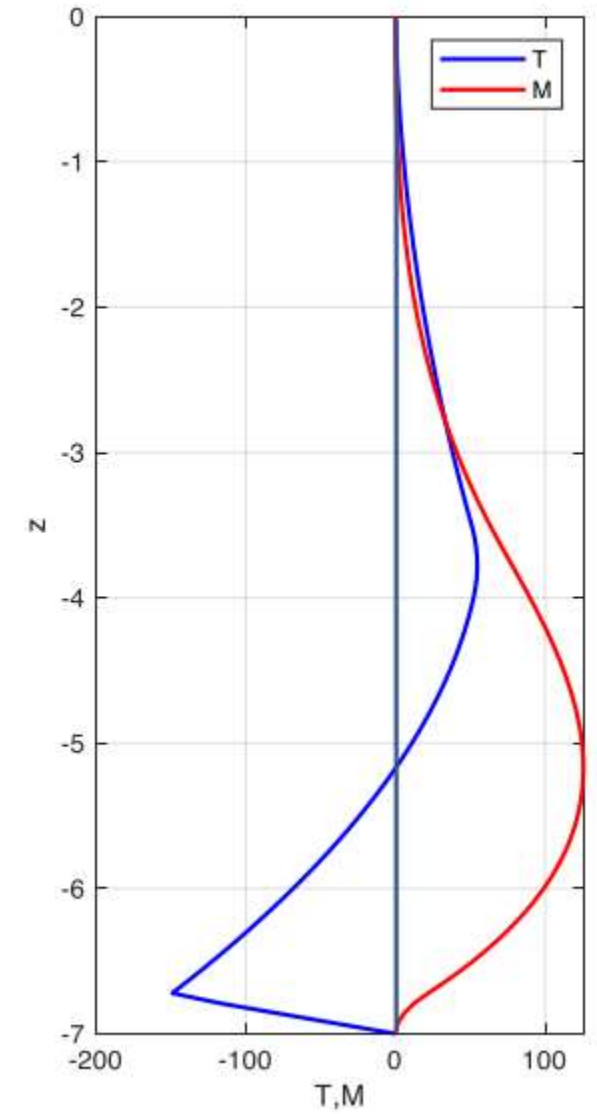
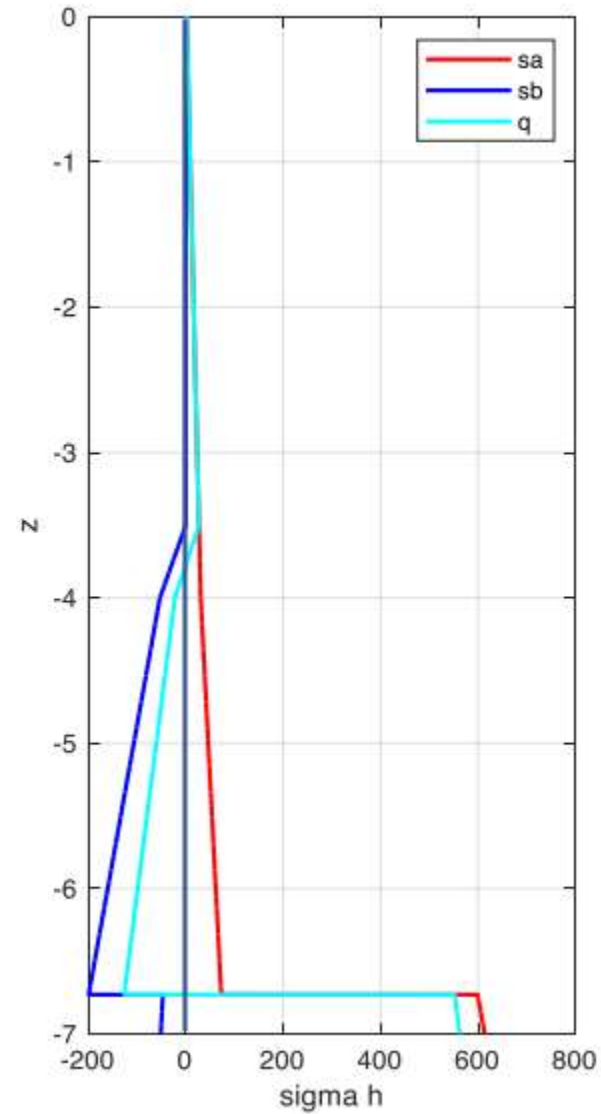

## non - displacing retaining structures

force – based approach → compare **capacity** and **demand of structural members**

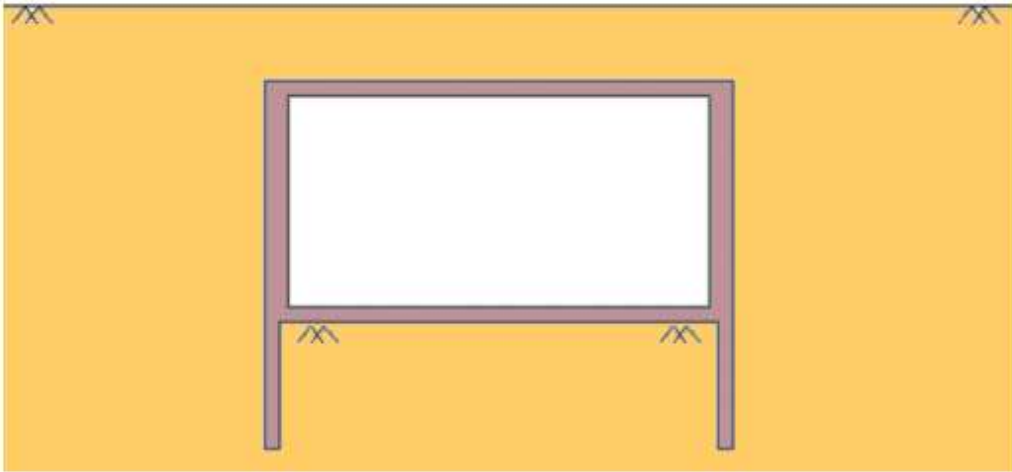

- static design method determines seismic calculation method
- apply seismic increments to static values

## non – displacing retaining structures

- empirical (e.g. Peck) → add 'elastic' soil pressure increment (e.g. **F.4**)
- subgrade reaction → examine static stress state:  
apply stress increments ( $K_{AE} - K_A$ ), reduce  $K_P$  to  $K_{PE}$   
**OR**  
apply 'elastic' stress increments (e.g. **F.4**)
- numerical model of continuum → add static equivalent forces to soil volume up to  $\alpha_H$

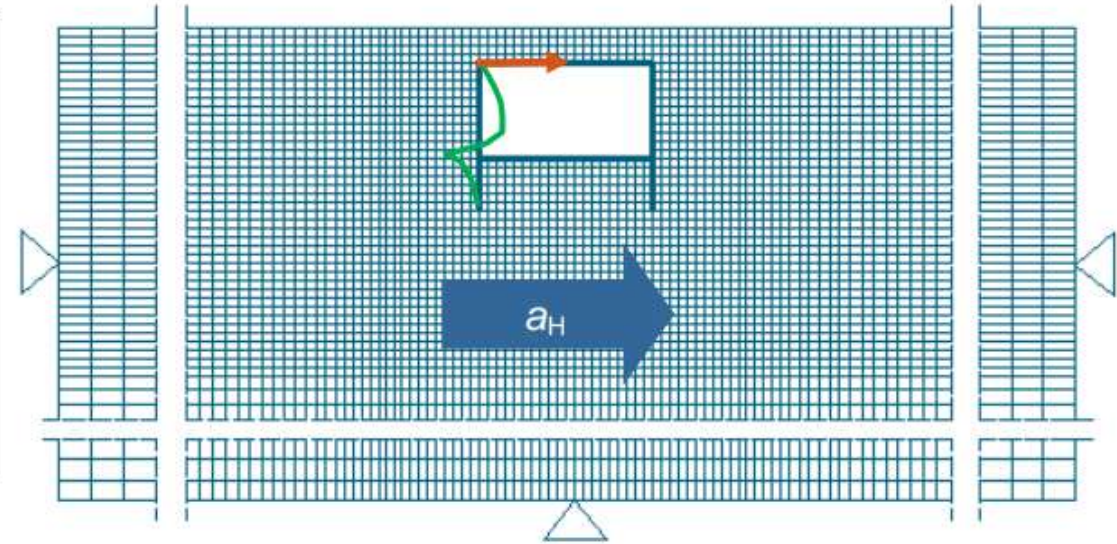
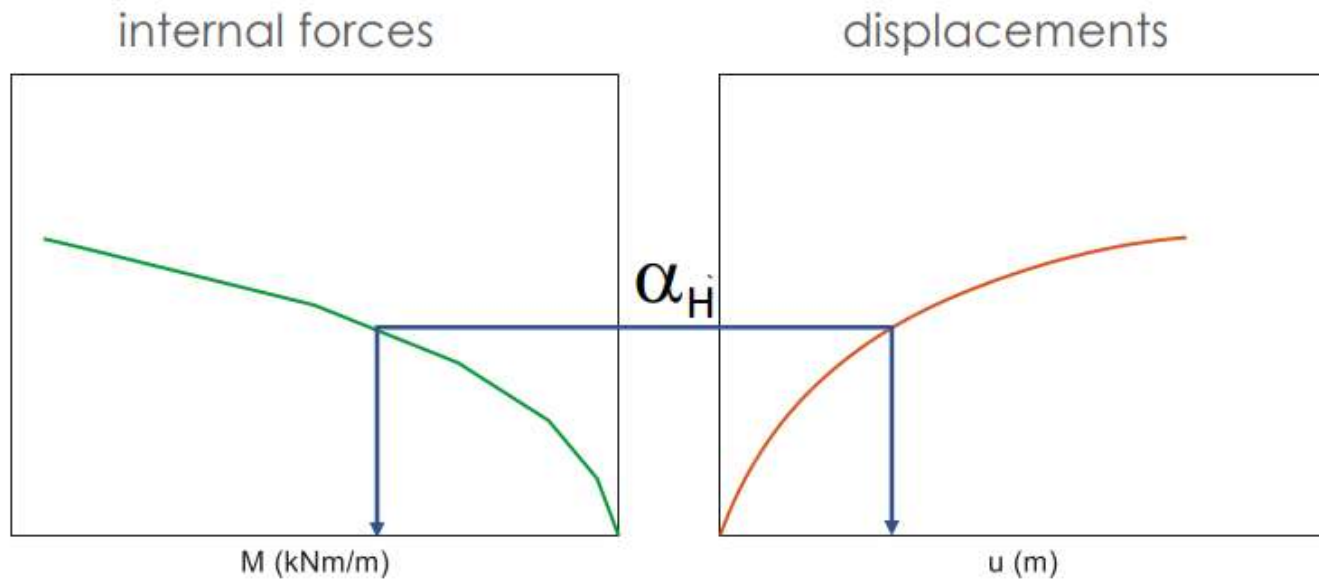

- numerical model of continuum

→ add static equivalent forces to soil volume up to  $\alpha_H$

## displacement-based approach

**demand:** calculated displacement

- (3) In a displacement-based approach, the seismic demand should be expressed as the residual displacement produced by the seismic action; it may be calculated with a dynamic analysis with acceleration time histories in accordance with **5.2(3)** and **EN 1998-1-1:2021, 5.2.3.1**.

**capacity:** allowed displacement

- (4) In a displacement-based approach, the seismic capacity should be expressed as the maximum residual displacement acceptable for the limit state under consideration.

# displacement-based approach: calculation models

## coupled models

- (1) In a displacement-based approach the ground and the structure may be modelled as a continuum in a global analysis or the seismic resistance may be calculated from a separate analysis.

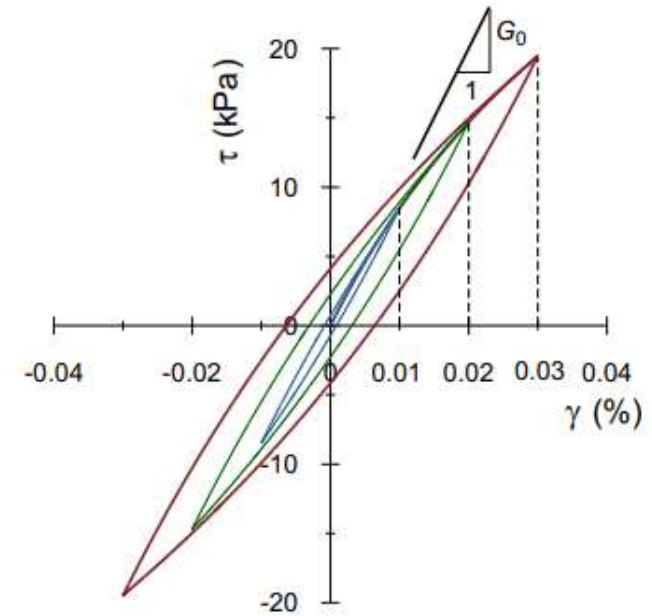
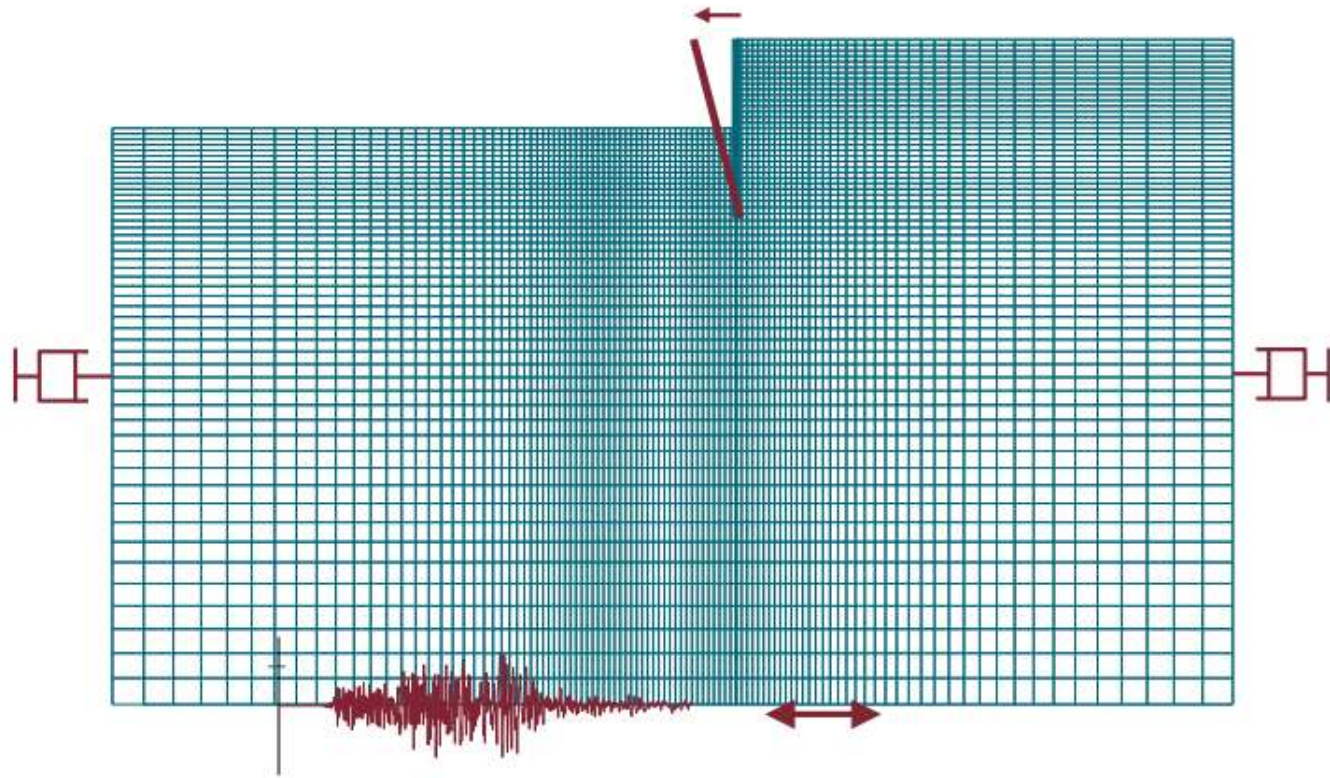



# displacement-based approach: calculation models

## coupled models

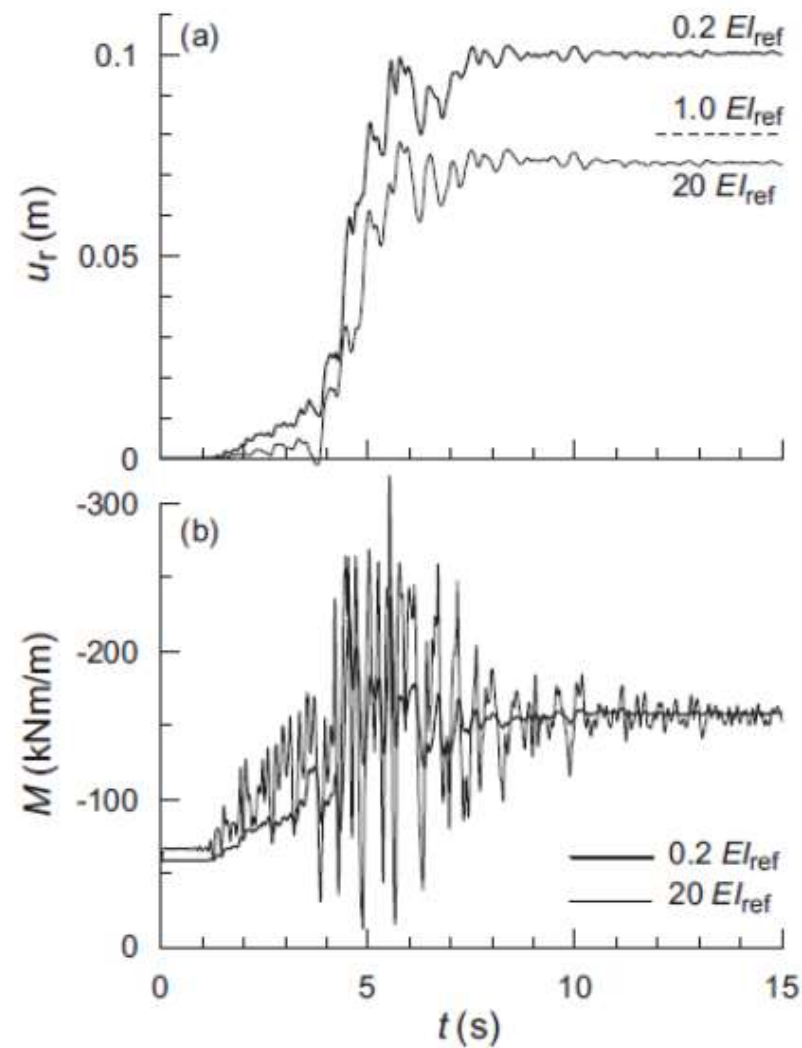
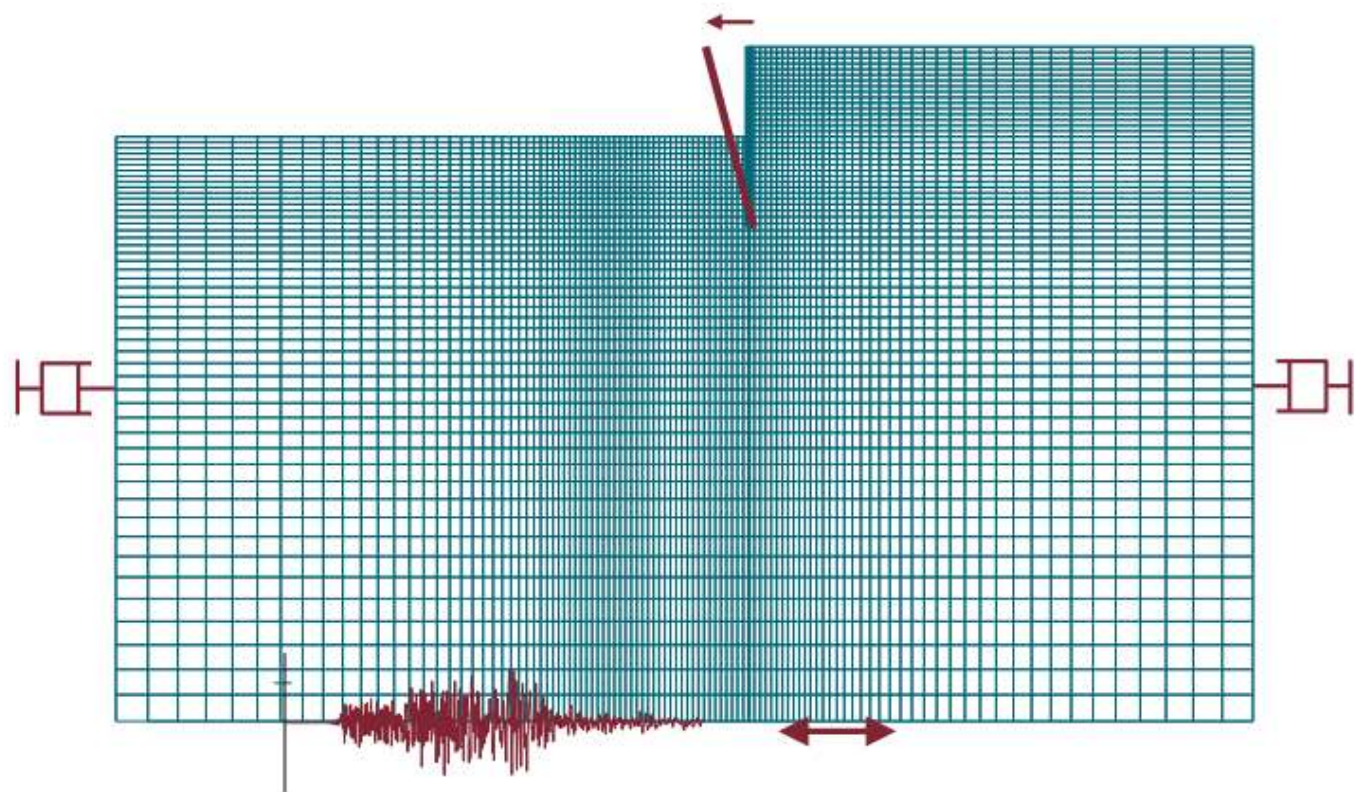

## displacement-based approach: calculation models

### uncoupled models

- (1) In a displacement-based approach the ground and the structure may be modelled as a continuum in a global analysis or the seismic resistance may be calculated from a separate analysis.

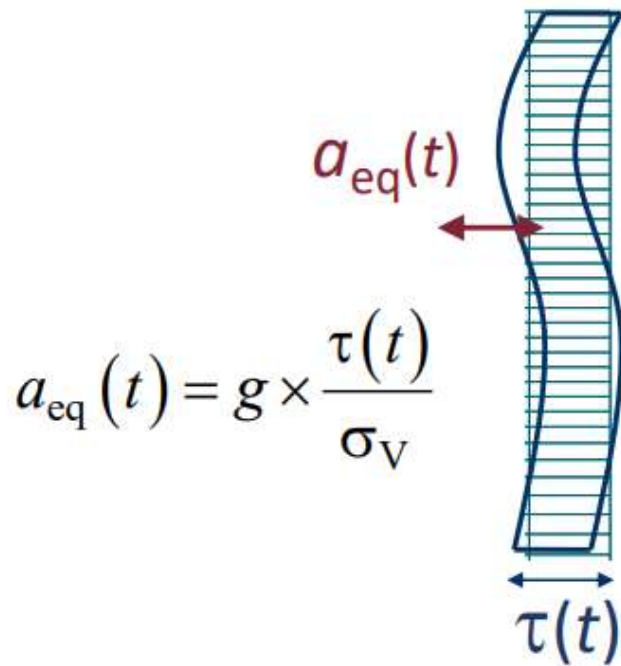

seismic action: free-field ground response analysis

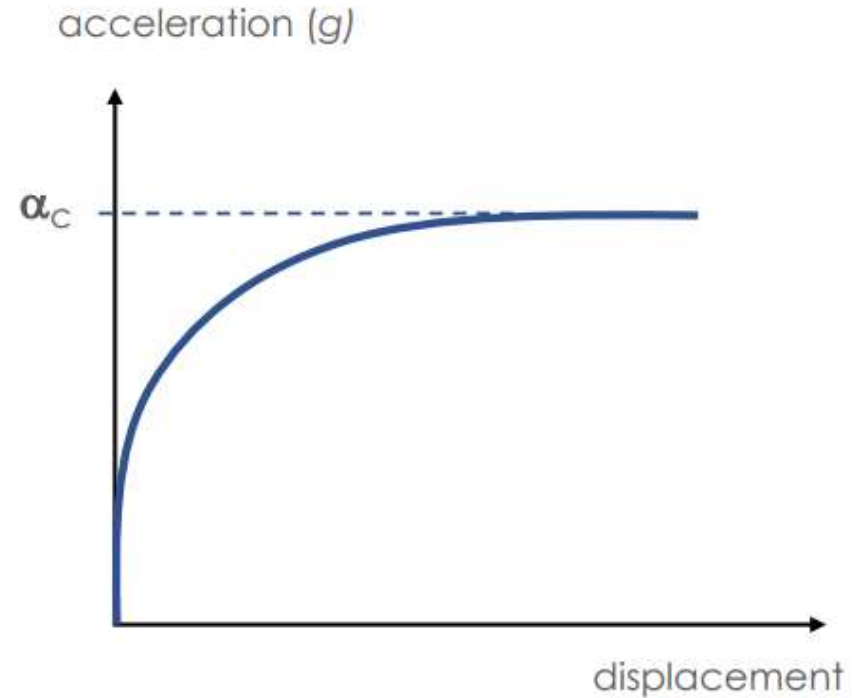
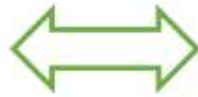

seismic resistance

## displacement-based approach: calculation models

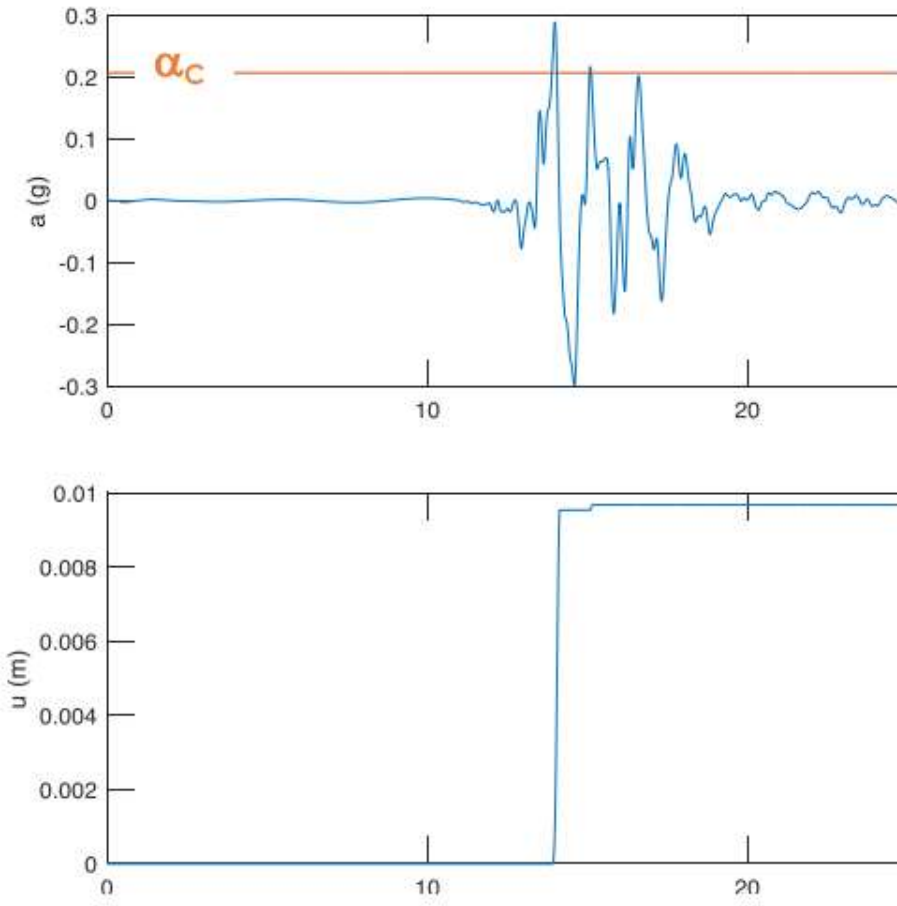

## Nemark (1965) rigid block approach

neglects the dynamic response of the system

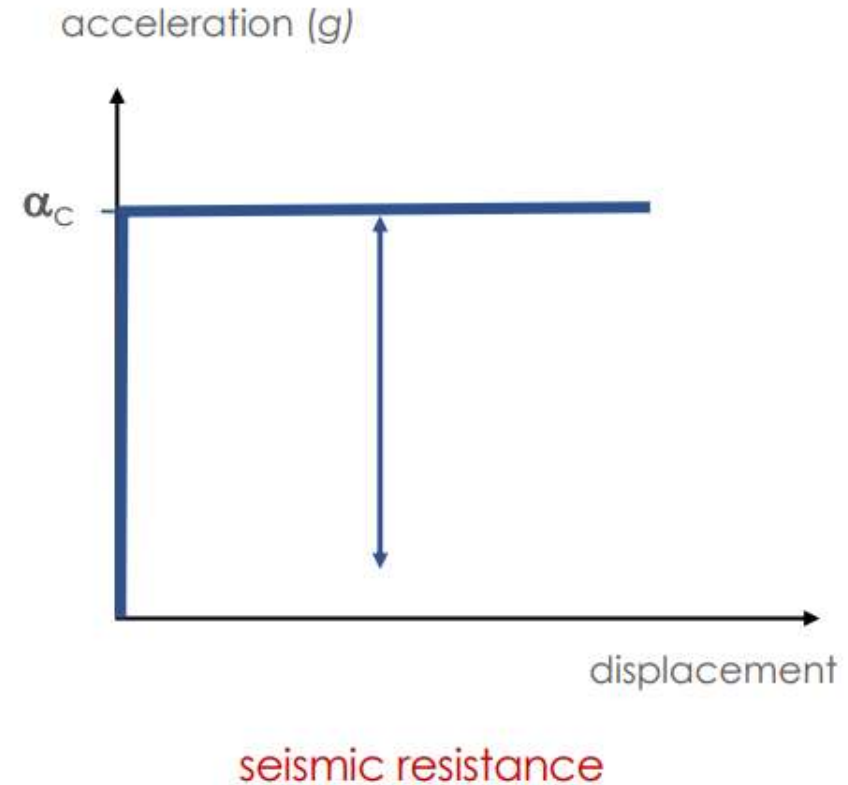

# displacement-based approach: calculation models

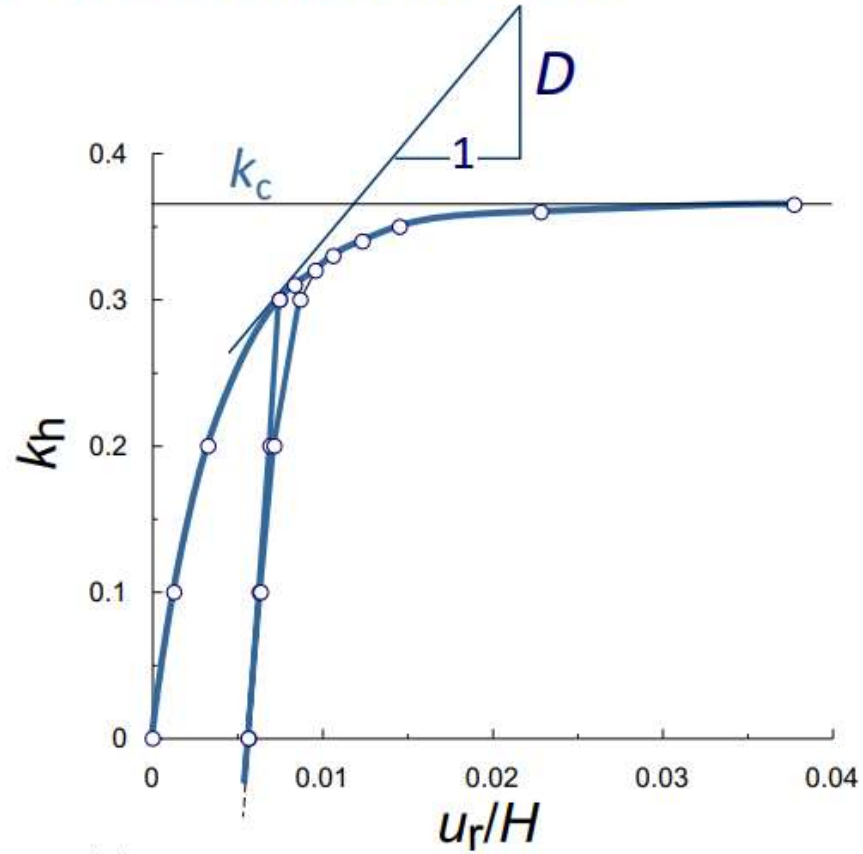
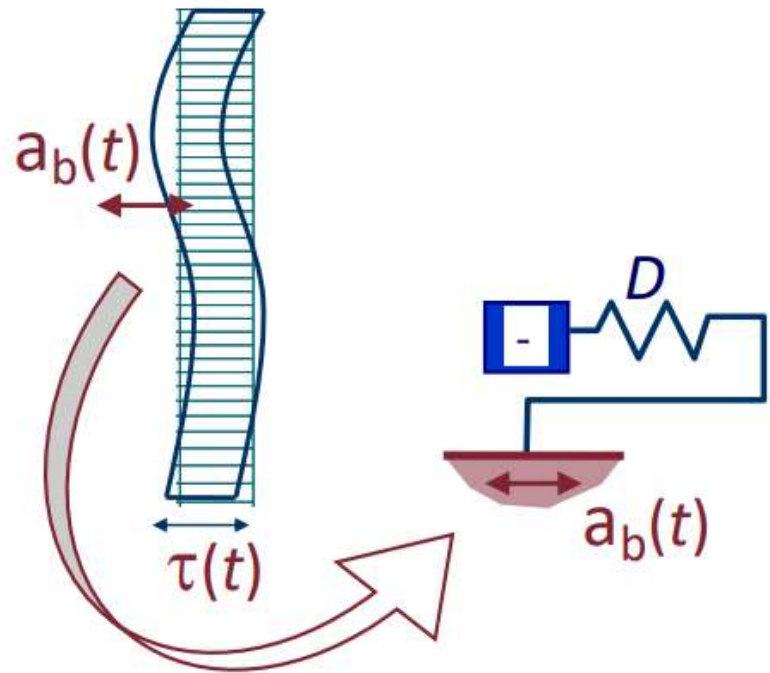

non-linear macro-element

$$\frac{\ddot{u}_r(t)}{g} + D(u_r/H) \times \frac{u_r(t)}{H} = -\frac{a_b(t)}{g}$$

Callisto, L. (2019). On the seismic design of displacing earth retaining systems. Keynote lecture, In: Proceedings of the 7th international conference on earthquake geotechnical engineering. Associazione Geotecnica Italiana, Rome.

## displacement-based approach: calculation models

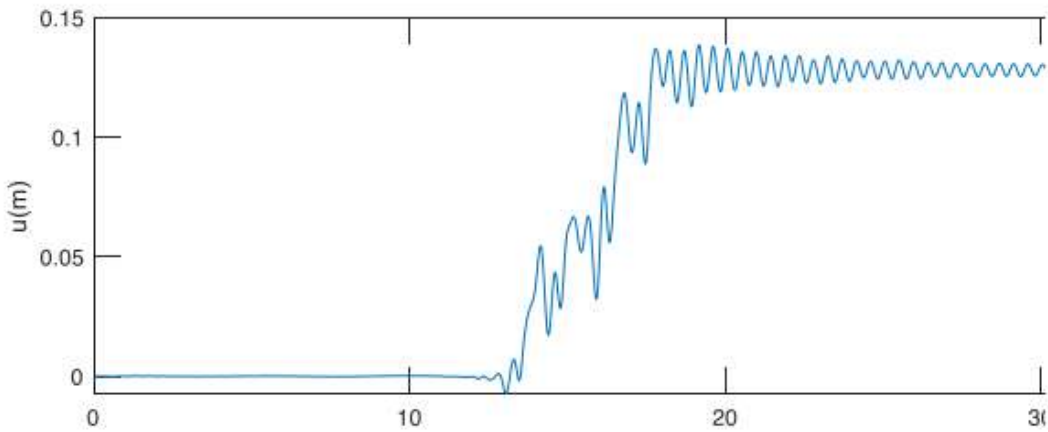
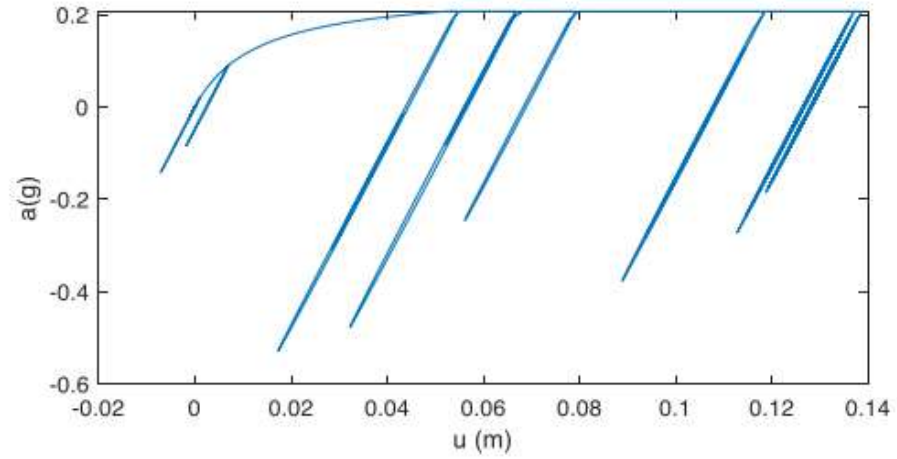
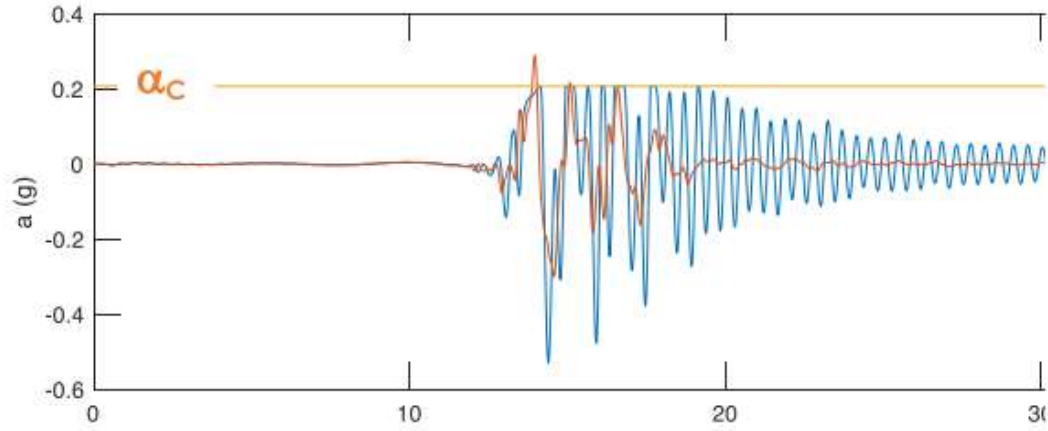

**non-linear macro-element**

# displacement-based approach

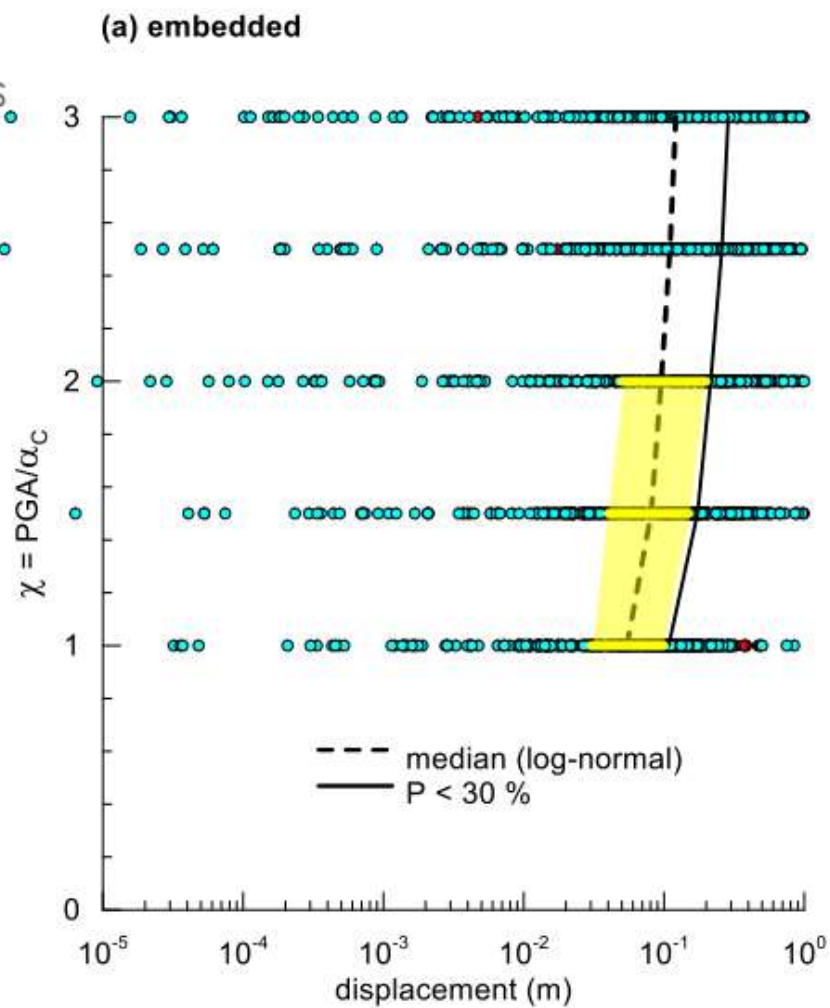
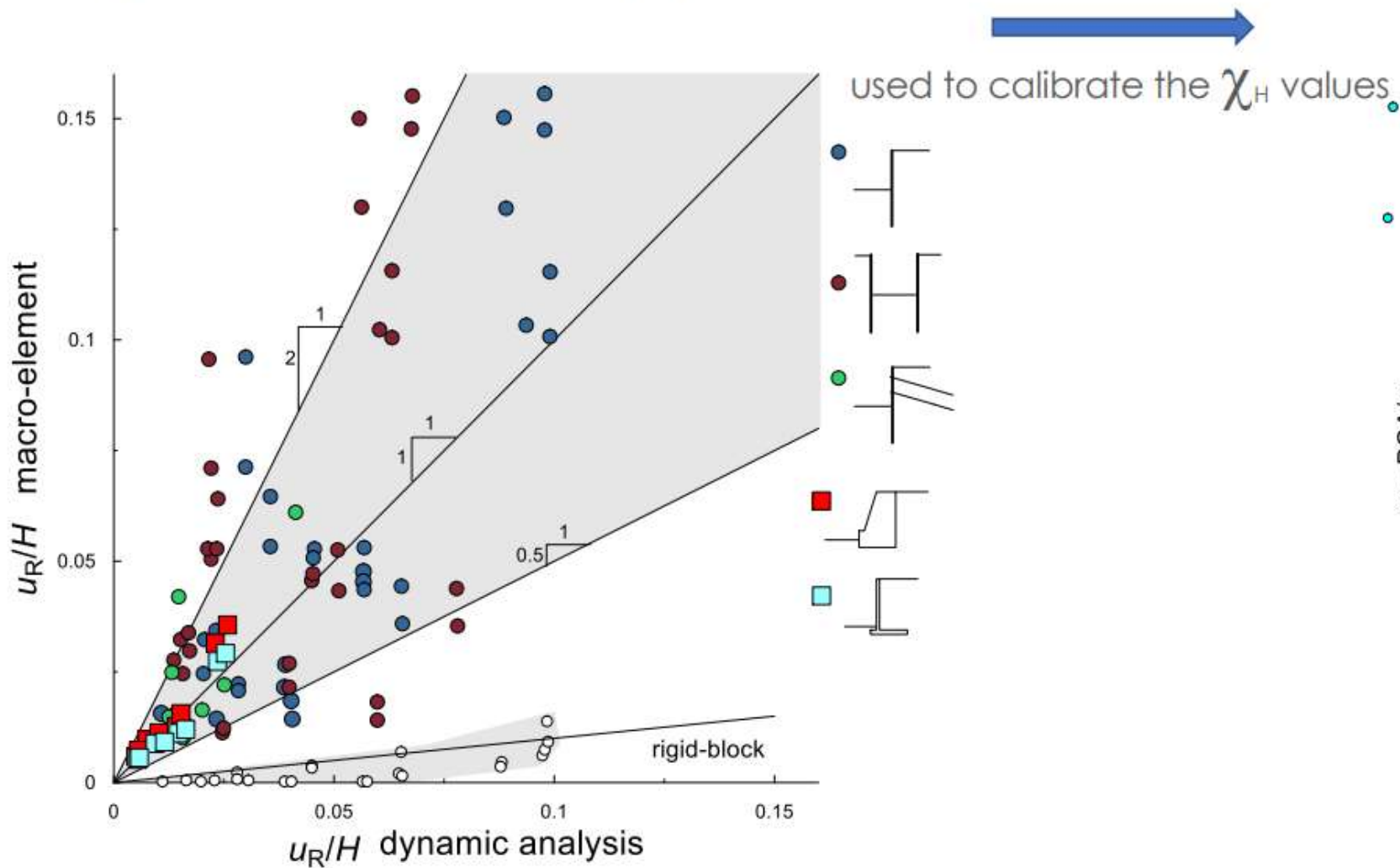

## displacement-based approach: calculation of internal forces

- compute max acceleration of the system
- calculate T, M from local model

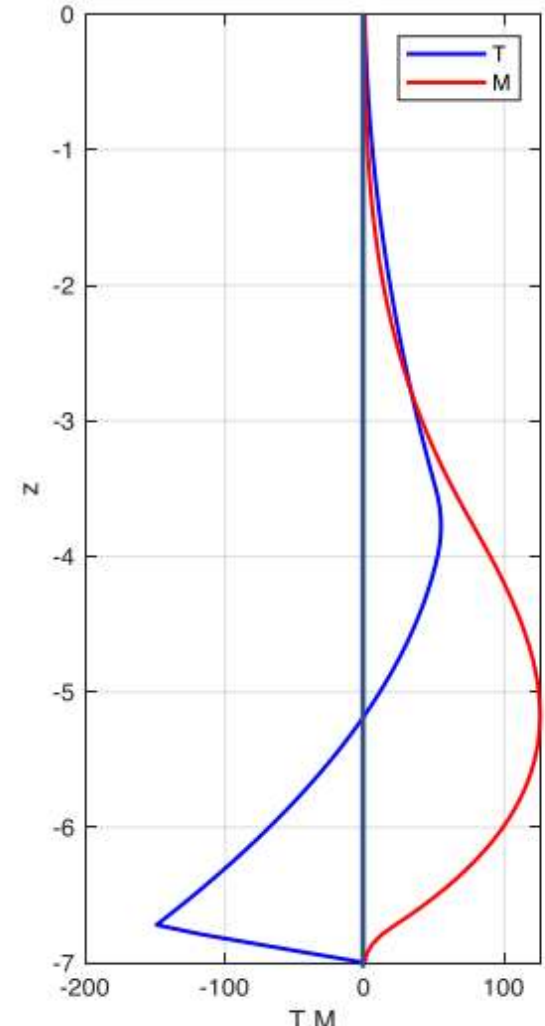
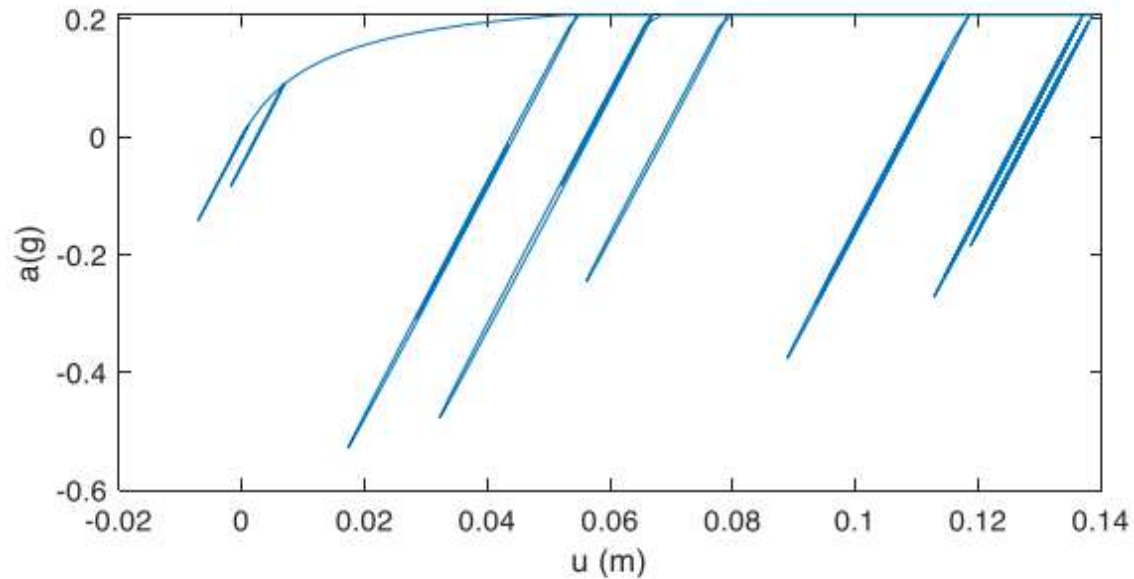

# EC8-5-11:2022 UNDERGROUND STRUCTURES

## 11.1 General

## 11.2 Seismic actions

11.2.1 General requirements

11.2.2 Ground motion parameters

11.2.3 Permanent ground displacement parameters

## 11.3 Methods of analysis

11.3.1 Seismic action for underground structures

11.3.2 Transient seismic action

11.3.3 Permanent ground deformation

## 11.4 Seismic loading for large underground spaces (parking and metro stations)

11.4.1 Ground shaking

11.4.2 Permanent ground displacements

## 11.5 Culverts



## 11.1 GENERAL

- **(1) P Tunnels** (bored, cut and cover, immersed) and **underground structures** (culverts and underground large works, like metro and parking stations, pipelines) shall be designed to provide seismic performance consistent with the limit states defined in EN 1998-1-1:2019, 4.4.1(1), EN 1998-3:2019, 4.1(2), and the associated seismic actions
- **(2) P** Underground structures shall be **designed against:**
  - ground shaking**
  - permanent ground deformations** due to seismic fault crossing, seismically induced landslides and liquefaction induced phenomena

## 11.1 GENERAL

- **(1) P Tunnels** (bored, cut and cover, immersed) and **underground structures** (culverts and underground large works, like metro and parking stations, pipelines) shall be designed to provide seismic performance consistent with the limit states defined in **EN 1998-1-1:2019, 4.4.1(1), EN 1998-3:2019, 4.1(2)**, and the associated seismic actions
- **(2) P** Underground structures shall be **designed against:**
  - ground shaking**
  - permanent ground deformations** due to seismic fault crossing, seismically induced landslides and liquefaction induced phenomena

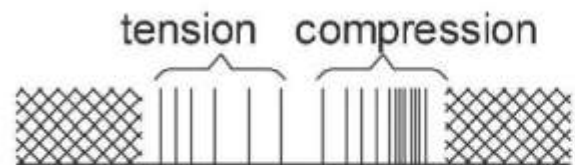

tunnel



compression-extension

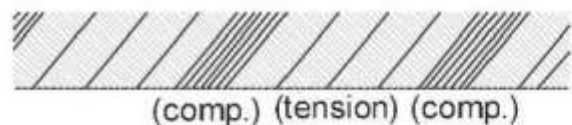

tunnel

(tension) (comp.) (tension)

diagonally propagating wave

tunnel during  
wave motion

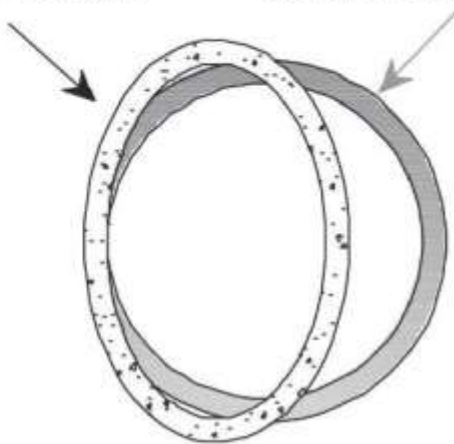

tunnel cross section  
before wave motion



compression of the tunnel section

tunnel during  
wave motion

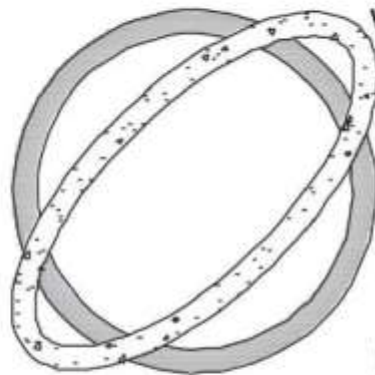

tunnel cross  
section  
before wave  
motion

shear wavefront



ovaling of the tunnel section

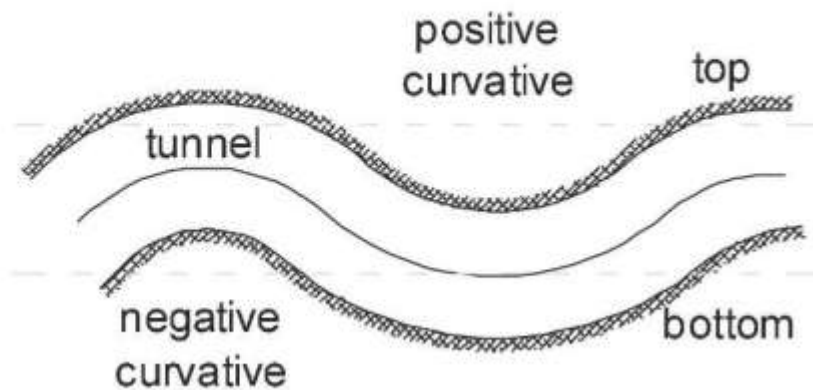

longitudinal bending

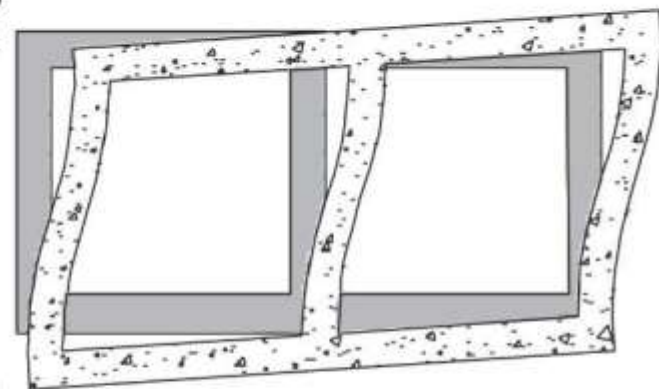

shear wavefront



racking of the tunnel section

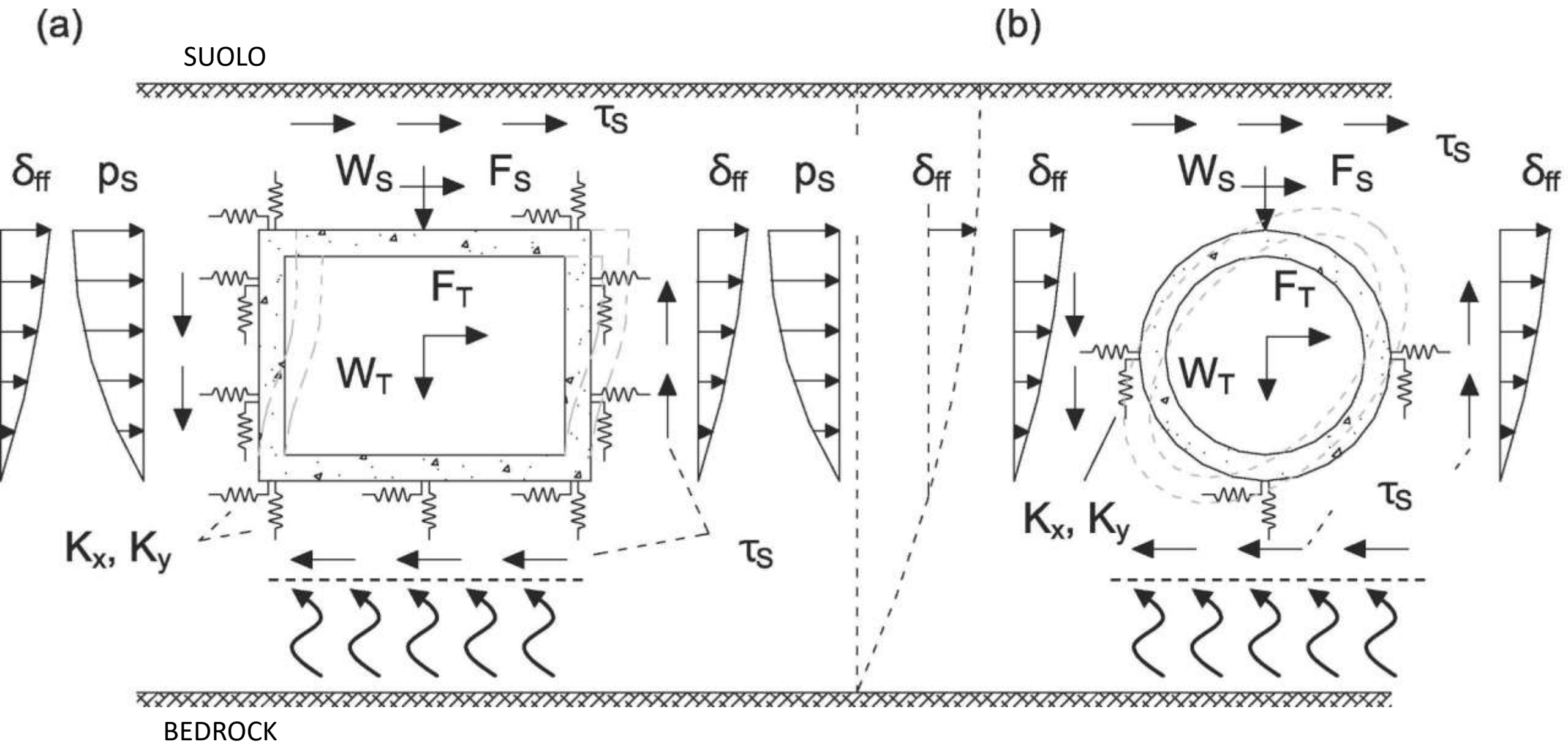

## 11.2.1 GENERAL REQUIREMENTS

- **(4)** Underground structures in **potentially liquefiable soils**

Specific ground response and liquefaction assessment should be carried out, according to § 7.5 and § 7.3, aimed at estimating the spatial variability of liquefaction and the severity of **buoyancy effects**

- **(5) Sites susceptible to hazards such as active faults, precarious slopes and potentially liquefiable soils should be avoided**, unless specific design and construction actions reduce the risk to acceptable limits!

## 11.2.2 GROUND MOTION PARAMETERS

- **(1)** Ground motion parameters should be established for the seismic design of tunnels and underground structures
- **(2) Low and moderate seismic action classes** → peak ground motion parameters *PGA, PGV, PGD* may be used

Design response spectra should be consistent with these parameters

- **(3)** For the evaluation of parameters at ground surface, various depths of the embedded structure, and at the depth of the base of the underground structure: **A ground-specific response analysis may** be carried out for this purpose

## Comments on modeling and seismic design of tunnels against longitudinal ground shaking

- Effect of **asynchronous ground motion** on the longitudinal seismic response of tunnels (time lag, incoherence of wave propagation, angle of incidence, difference in soil conditions etc.)

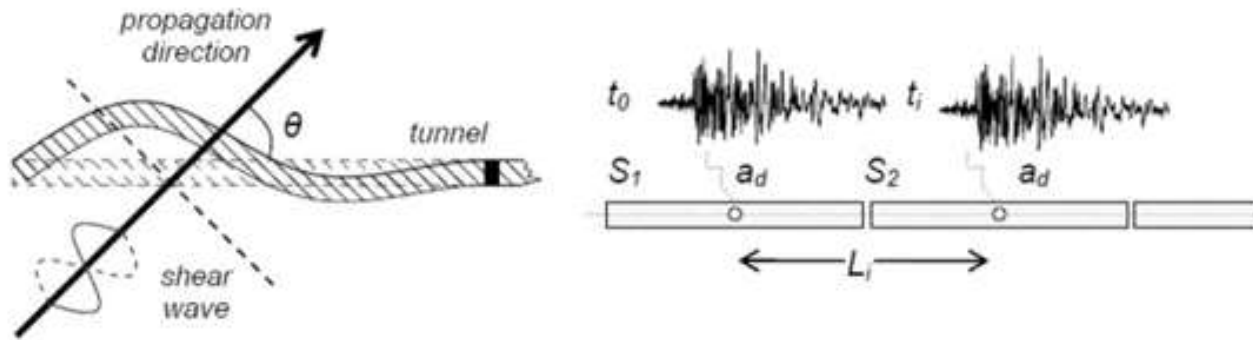

- Seismic response and design of **joints** for any kind of tunnels
- Seismic design of connections between tunnels and other embedded structures (e.g. metro stations, shafts, etc.)
- Segmental lining may be simulated in a simplified fashion by reducing the lining of **equivalent continuous lining** as per Wood (1985) (or other appropriate methods).



## Analytical solutions for analysis in longitudinal direction

**Assumption: soil-structure interaction is either ignored (free-field approach) or considered**

- The **seismic internal forces** in the lining under a harmonic horizontal shear wave propagating in the horizontal direction may be calculated via the following formulae:

Wave excitation	Free field approach	Soil structure interaction approach
	$M = \frac{E_1 I_1}{\rho} = \left(\frac{2\pi}{L}\right)^2 \cos^3 \varphi E_1 I_1 A \sin\left(\frac{2\pi x}{L / \cos \varphi}\right)$	<p style="color: red;">Soil compliance</p> $\{M, V, P\}_{ssi} = \frac{\{M, V, P\}_f}{1 + \frac{E_1 I_1}{K_h} \left(\frac{2\pi}{L}\right)^4 \cos^4 \varphi}$
$u_y = \cos \varphi \sin\left(\frac{2\pi x}{L / \cos \varphi}\right) A$	$V = \frac{\partial M}{\partial x} = \left(\frac{2\pi}{L}\right)^3 \cos^4 \varphi E_1 I_1 A \cos\left(\frac{2\pi x}{L / \cos \varphi}\right)$	$Q_{ssi} = \frac{Q_f}{1 + \frac{E_1 A_1}{K_a} \left(\frac{2\pi}{L}\right)^2 \cos^2 \varphi}$
$u_x = \sin \varphi \sin\left(\frac{2\pi x}{L / \cos \varphi}\right) A$	$P = \frac{\partial V}{\partial x} = \left(\frac{2\pi}{L}\right)^4 \cos^5 \varphi E_1 I_1 A \sin\left(\frac{2\pi x}{L / \cos \varphi}\right)$	
	$Q = \left(\frac{2\pi}{L}\right) \sin \varphi \cos \varphi E_1 A_1 A \cos\left(\frac{2\pi x}{L / \cos \varphi}\right)$	
<p>A : shear wave amplitude, L : shear wave wavelength, <math>\varphi</math> : angle of incidence, M : bending moment, V : shear force, P : equivalent load density (per unit length), Q : axial force, <math>K_h, K_a</math> : transversal and axial soil moduli</p>		

- Impedance functions (springs) necessary to account for SSI effects:

$$K_{h,a} = \frac{16\pi G_s (1-\nu_s) d}{(3-4\nu_s) L}, \quad K_v = \frac{2\pi G_s d}{(1-\nu_s) L}$$

St. John & Zahrah (1981)



## 11.2.2 GROUND MOTION PARAMETERS

- **(4) Moderate and high seismic action classes** → **a ground-specific response analysis should** be carried out along the total length of the structure
- **(5)** For **low seismic action classes** and in the absence of site-specific ground response analysis, the **ground motion parameters at depth  $z$**  in clauses (1) and (2) may be calculated from **PGA** at ground surface, (e.g., EN 1998–1–1:2019, 5.2.2.4) using simplified expressions
- **(6)** In the absence of site-specific response analysis the values of  **$PGV(z)$**  and  **$PGD(z)$**  may be estimated using empirical correlations

**Annex G** provides simplified expressions and empirical relations

## 11.2.2 GROUND MOTION PARAMETERS

- **Annex G** provides:
  - Simplified relations to estimate **PGA** distribution with depth
  - Empirical correlations between **PGA, PGV** and **PGD**
  - Formulae to estimate **ground shear stresses** distribution with depth
  - Recommendations for the estimation **of spatial variation and incoherence of the ground motion**

## Analytical solutions for circular tunnels

### Assumption: soil-structure interaction is considered

- When **full slip interface condition** is considered at the interface between the ground and the tunnel, the following formulae may be used to calculate diametric change of the cavity and the seismic forces in the lining

$$\frac{\Delta d_t}{d_t} = \pm \frac{1}{3} K_1 F_R \gamma_{\max} \quad N_{Ed} = \pm \frac{1}{6} K_1 \frac{E_s}{(1+\nu)} r_L \gamma_{\max} \quad M_{Ed} = \pm \frac{1}{6} K_1 \frac{E_s}{(1+\nu)} r_L^2 \gamma_{\max}$$

$$K_1 = \frac{12(1-\nu)}{2F + 5 - 6\nu} \quad N_{ed} \text{ and } M_{Ed} \text{ the maximum design axial force and bending moment, respectively}$$

- The ovaling ratio of the circular shape tunnel may be calculated as follows

$$R_c = \frac{\Delta d_{\text{stru}}}{\Delta d_t} = \frac{2}{3} K_1 F_R = \frac{4(1-\nu)F_R}{2.5 - 3\nu + F_R}$$

$\Delta d_t$  is given before and  $\Delta d_{\text{stru}}$  is the diametric change of the cross section of the lining

- Similar expressions are available for **non-slip interface condition**

Wang (1993), Hashash et al. (2001)

## Simplified analysis methods for rectangular tunnels

### Assumption: soil-structure interaction is considered

- In case of rectangular cross sections, soil structure interaction is affected significantly by the soil to structure relative stiffness, which for a rectangular cross section may be estimated via the **flexibility ratio  $F_R$**

$$F_R = \frac{GW}{PH}$$

$P$ : is the horizontal force applied to the roof and the invert slab of the section of the tunnel to cause a unit racking deflection, estimated through simple static elastic frame analysis

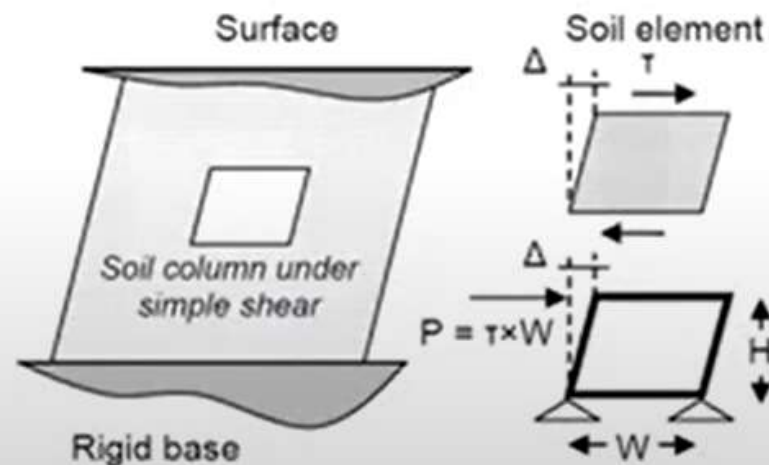

Wang (1993), Hashash et al. (2001)

## Simplified analysis methods for rectangular tunnels

**Assumption: soil-structure interaction is considered**

- The hypothesis of **racking distortion** is proved experimentally and numerically. However as shown below except of the racking there exist also a **rocking response pattern** as well as **dazzling-squeezing effects**, depending on the soil to tunnel relative flexibility

Stiff-rigid tunnel compared to surrounding ground

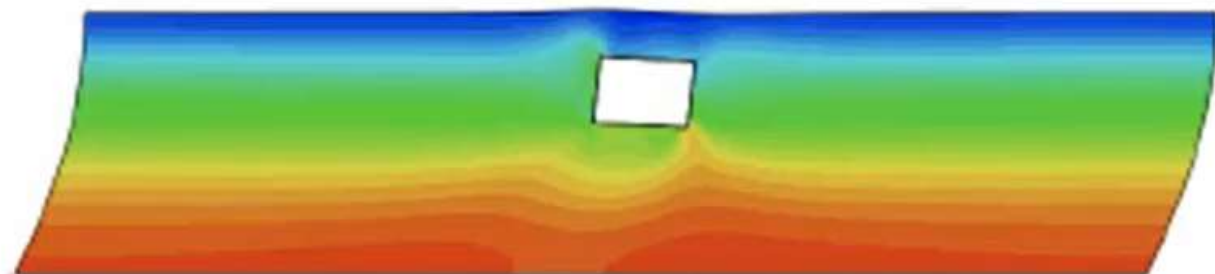

(a)

Flexible tunnel compared to surrounding ground

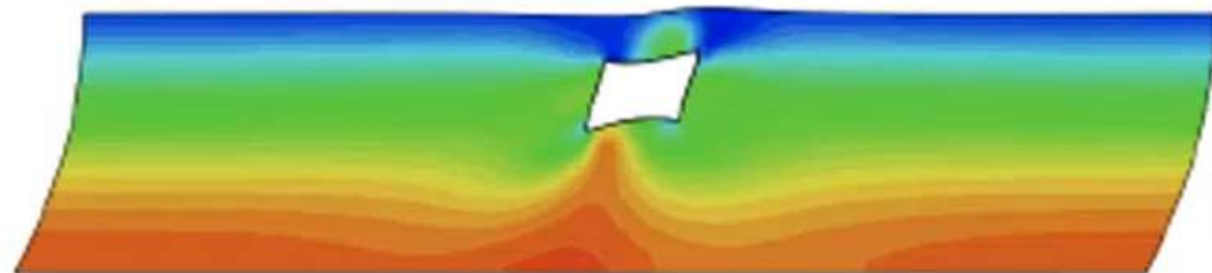

(b)

Pitilakis and Tsinidis (2014)

## Simplified analysis methods for rectangular tunnels

---

- Assuming **pure racking response of the structure**, the structural racking deformation may be calculated via the racking ratio  $R_r$  defined in Formulae below:

$$R_r = \frac{\delta_{str}}{\delta_{ff}}$$

No-slip interface condition

$$R_r = \frac{4(1-\nu)F_R}{3-4\nu+F_R}$$

Full-slip interface condition

$$R_r = \frac{4(1-\nu)F_R}{2.5-3\nu+F_R}$$

$\delta_{ff}$

is the free-field racking ground displacement at the burial depth of the structure

$\delta_{str}$

is the structural horizontal deflection of the lining

Penzien (2000), Hashash et al. (2001)



# Beam on soil-springs model

## Assumption: soil-structure interaction is considered

- Circular or rectangular tunnels subjected to seismic ground shaking in the longitudinal direction may be analysed employing a beam on soil-springs model
- **Seismic loading** is introduced either **statically**, or in terms of **time history ground displacements** at the free end of the springs
- **Spatial variation of the ground motion** should be considered
- Soil-structure-interaction effects in the longitudinal direction generally reduce the internal forces in the lining, while spatial variation of ground motion increase the response of the structure

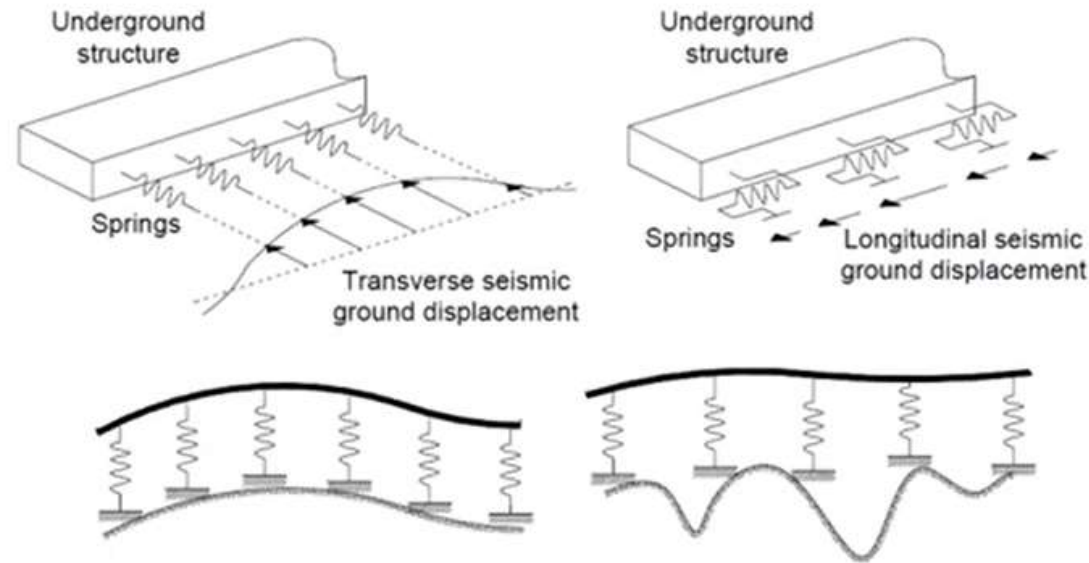

# Example: spring model for tunnels



a.

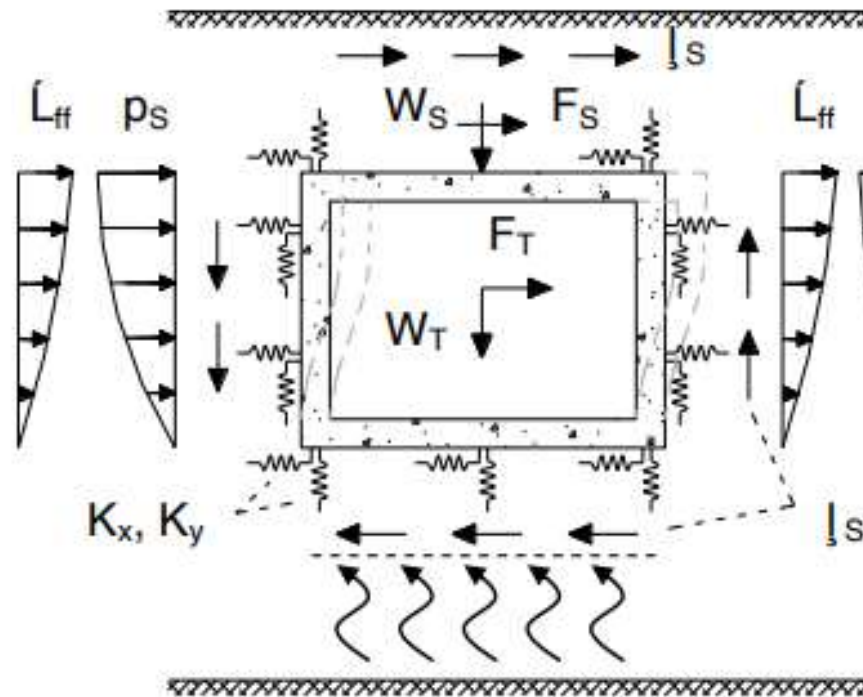

b.

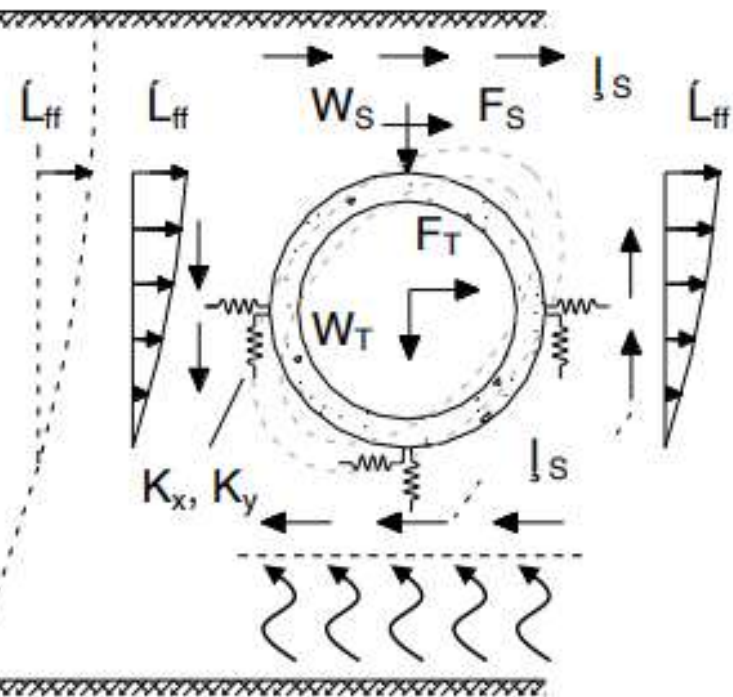



## Simplified analysis methods for rectangular tunnels - steps

1. Compute soil free-field deformation  $\Delta_{ff}$

2. Evaluate flexibility ratio,  $F$

$$F = \frac{G_s \times W}{S \times H}$$

3. Evaluate racking ratio,  $R$

4. Evaluate structural distortion  $\Delta_{structure}$

$$\Delta_{structure} = R \times \Delta_{ff}$$

5. Perform a static frame analysis for the computed structural distortion

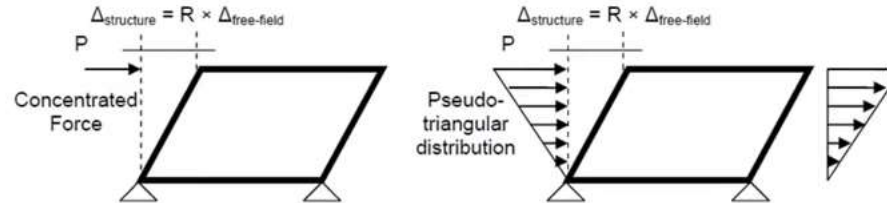
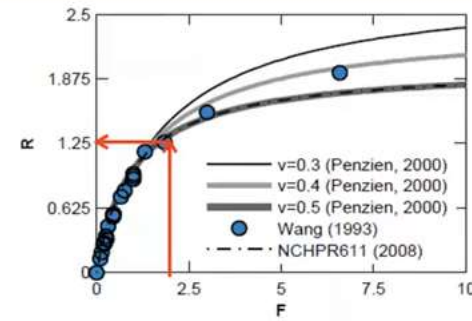

Wang (1993)

## 11.2.2 GROUND MOTION PARAMETERS

- **(7)** For the **seismic action in the longitudinal direction of tunnels** and pipelines, an **apparent velocity ( $V_{app}$ )** should be considered.
- **(8)** Absence of site-specific studies?  $V_{app}$  may be taken equal to 1000 m/s

## 11.2.2 PERMANENT GROUND DISPLACEMENT PARAMETERS

- **(1)** For **seismic faulting, seismically triggered landslides, or liquefaction**, as defined in § 7.1.1, § 7.2 and § 7.3, the **permanent ground displacements** should be calculated together with other relevant design parameters **for the design return period and the category of structures under consideration**
- **(2)** For permanent ground displacements not covered in (1), specific studies should be performed

## 11.3.2.2 GROUND DEFORMATION IN TRANSVERSE & LONGITUDINAL DIRECTION

- **Main deformation modes** for transverse response of tunnels

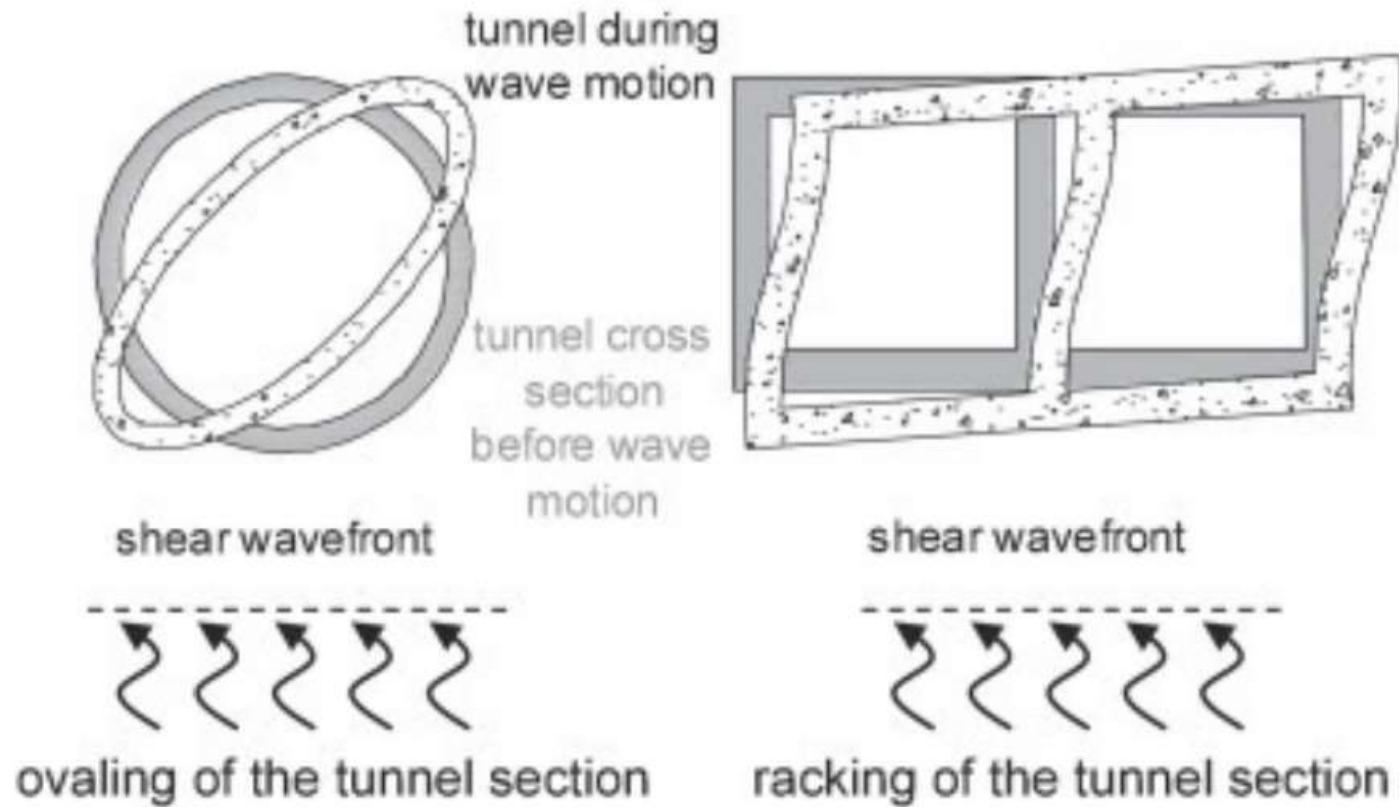

## 11.3.2.2 GROUND DEFORMATION IN TRANSVERSE & LONGITUDINAL DIRECTION

- (7) When **soil-structure interaction effects are considered** for the seismic analysis in the **transverse direction**, the model may follow § 8.3 using springs (normal and tangential) consistent with the vibration modes and the dominating deformation pattern

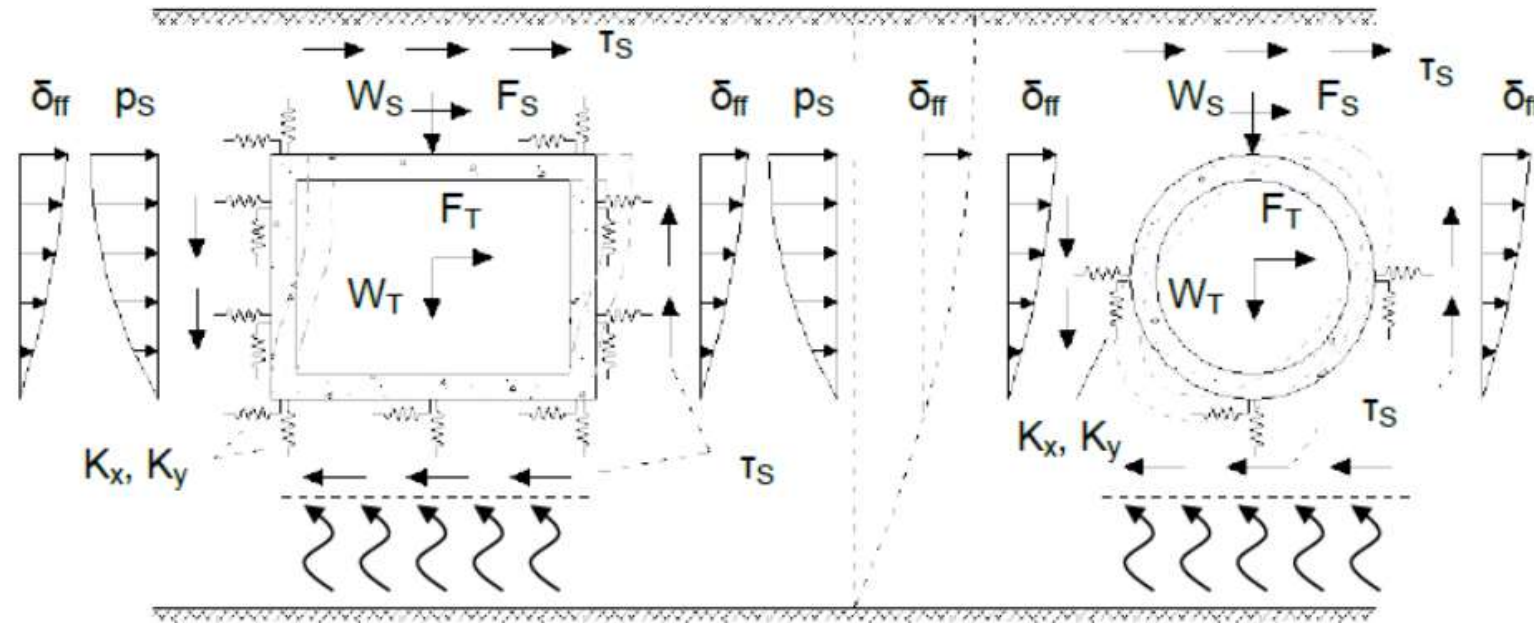

## 11.5 CULVERTS

- Typical structures (rigid-flexible) in transportation and hydraulic networks generally of short length and dimensions
- Consider the seismic response of the ground, the embankment and earth fill in which they are embedded
- Culverts are particularly vulnerable to permanent ground deformations!
- Effects of transient ground shaking may be neglected for culverts, of any shape and typology, with less than 2,0 m span and may be designed according to § 11.1 to § 11.3 for large dimension culverts
- Design of **joints of segmental culverts**: Provide enough deformation capacity in tension and compression to withstand transient and permanent longitudinal ground displacements

# KAMENA VOURLA BYPASS CUT AND COVER TUNNEL

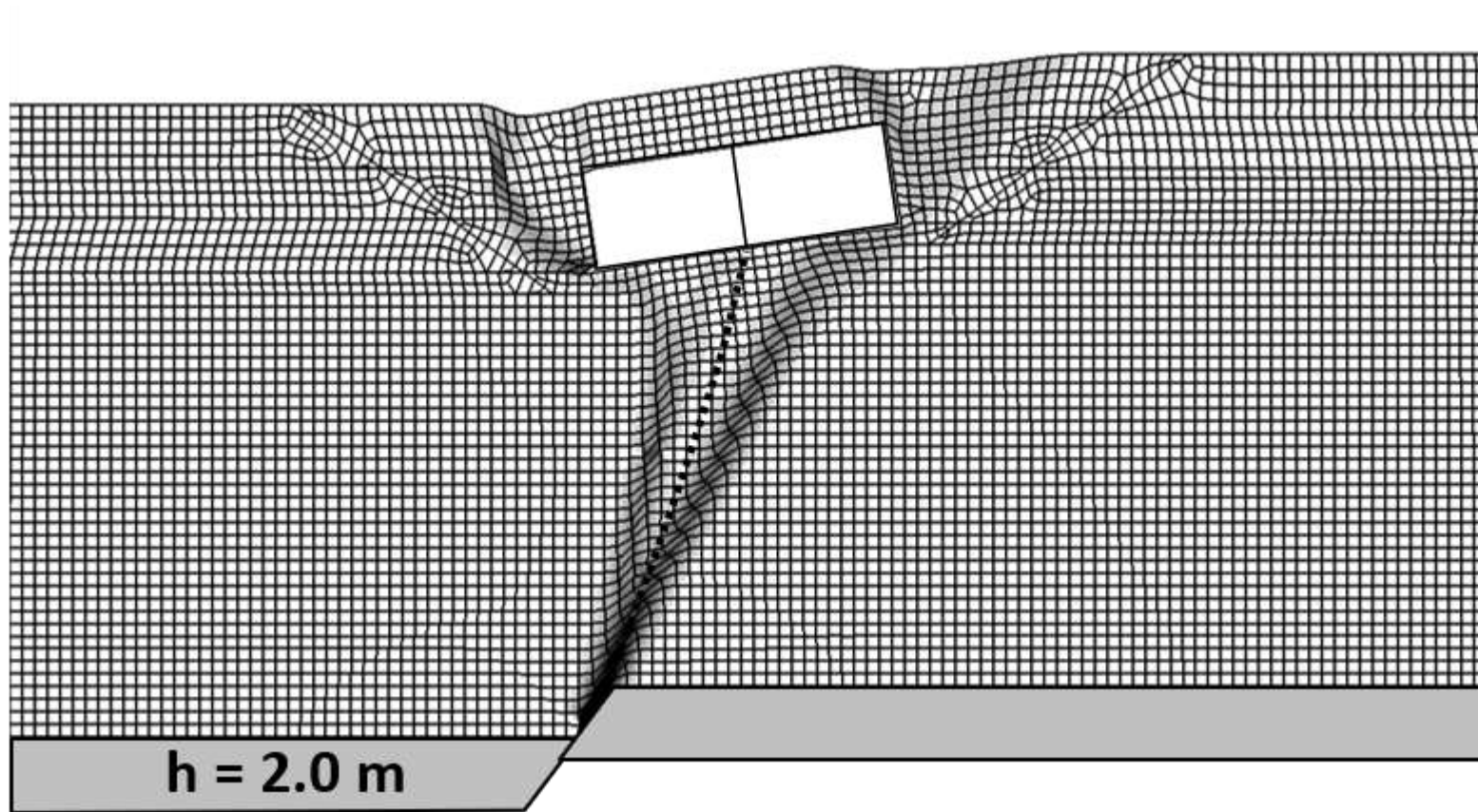

# PORT OF PIRAEUS

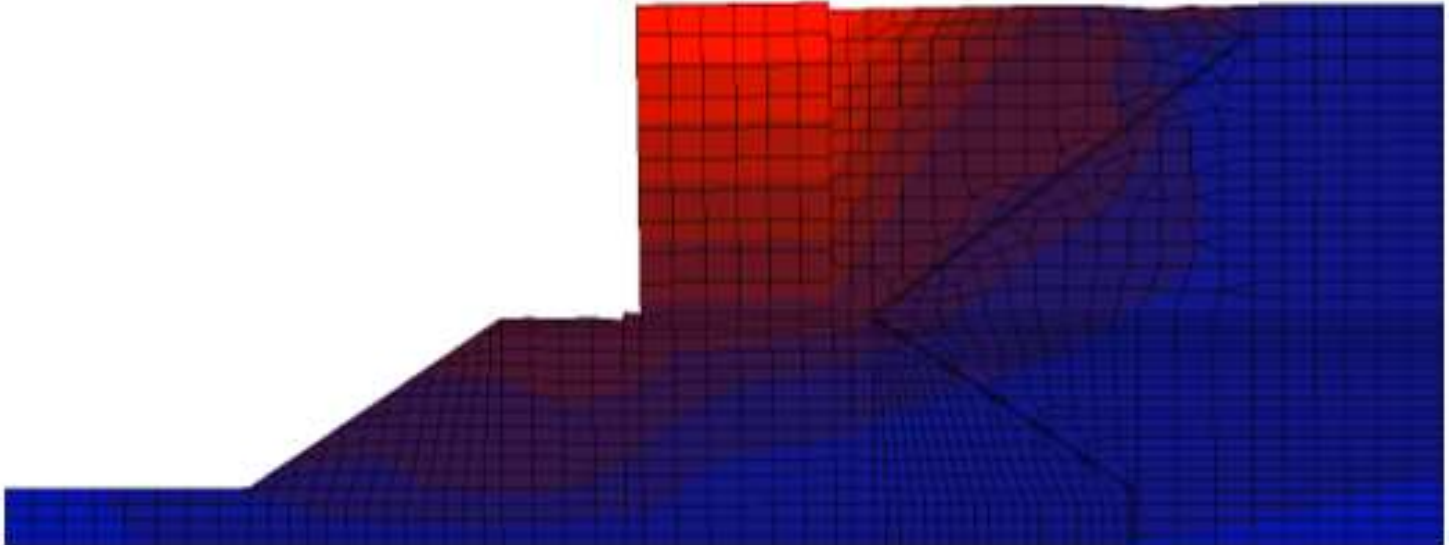
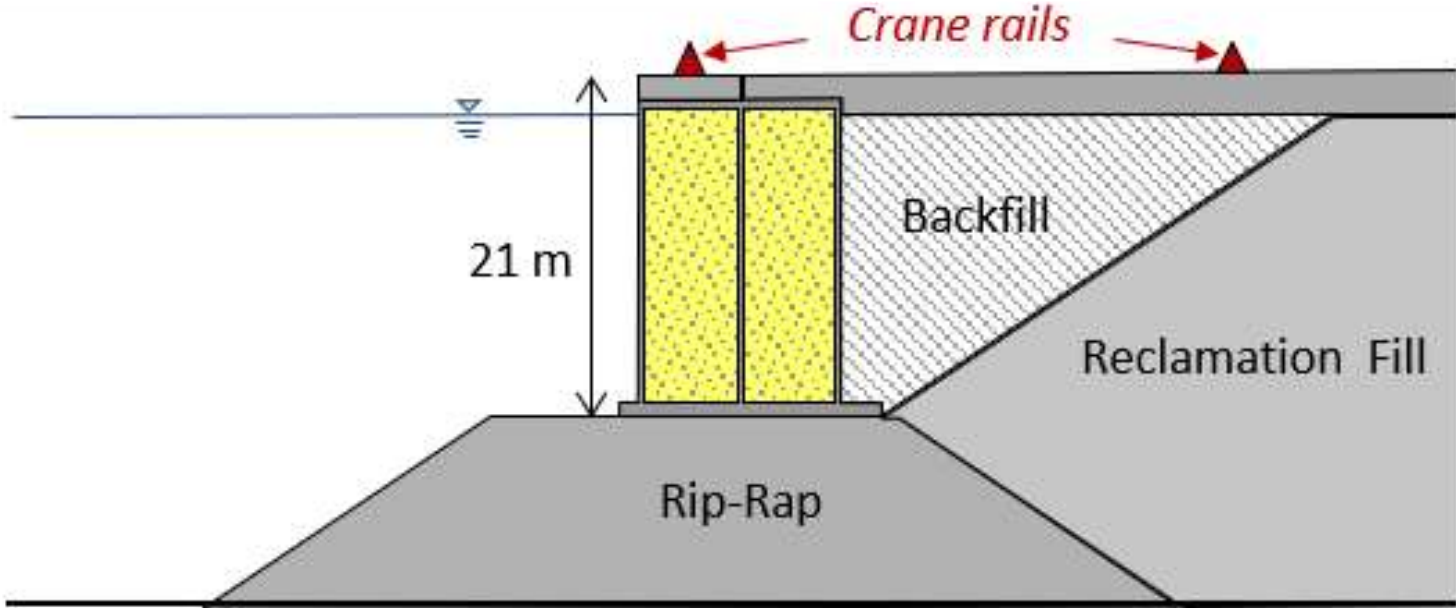



**Masonry:** 3D nonlinear continuum elements

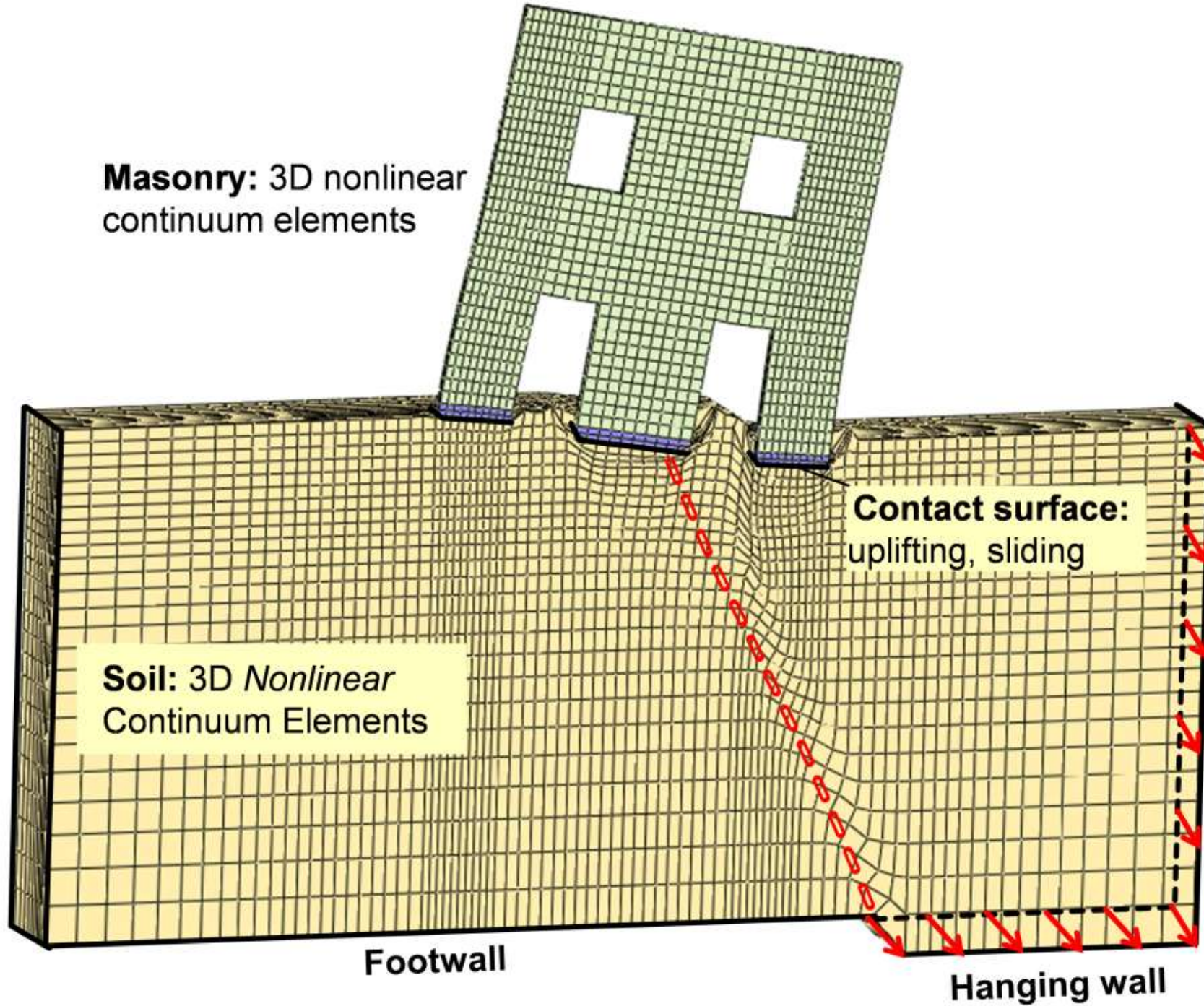

# EC8-5-10 GEOTECHNICS

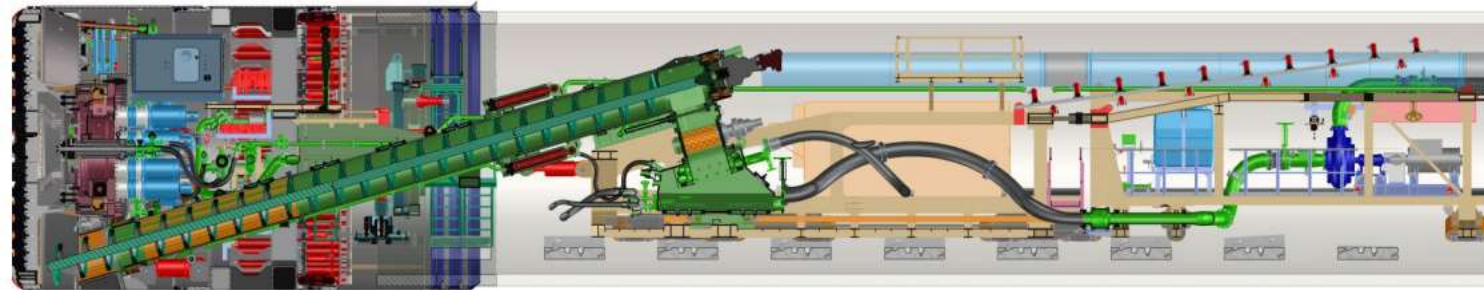

## EPB APPLICATION

## SLURRY APPLICATION

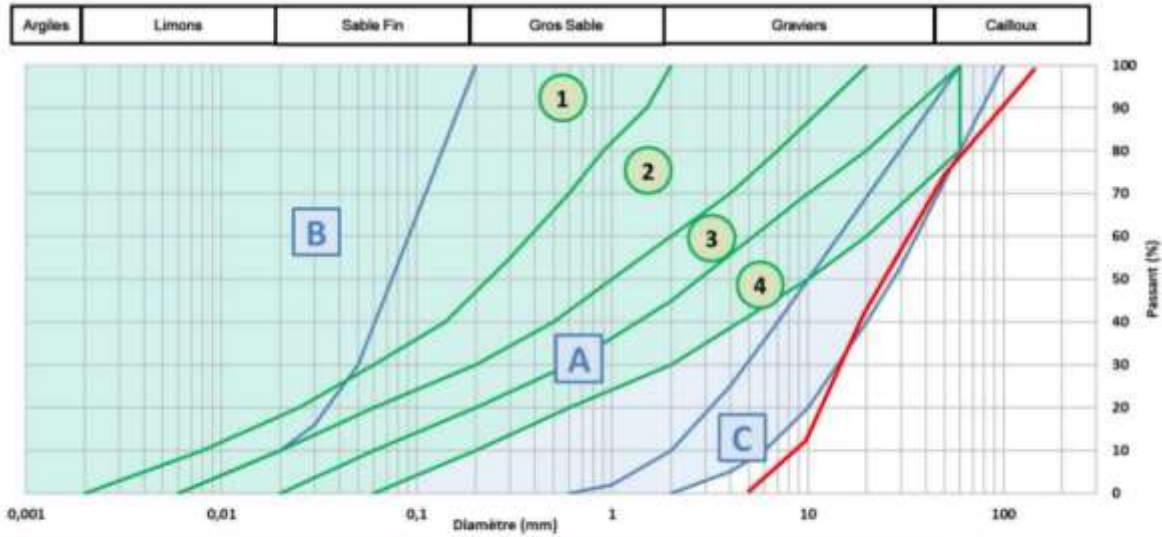

**EPB application ranges after Thewes 2007:**  
 1 : Water to improve consistency, foam to reduce stickiness  
 2 : Foam  
 3 : Foam + polymers, water pressure <2 bar  
 4 : Foam + polymers + fines, no water pressure

**Slurry TBM application ranges after Thewes 2009:**  
 A : Standard application an separation  
 B : Measures against clogging, intense separation effort  
 C : Face support difficult: suspension and fillers

— High permeability alluvium sample

# BRENNERO BASE RAIL TUNNEL D 10,5 M DOPPIO SCUDO



Variable  
Density TBM

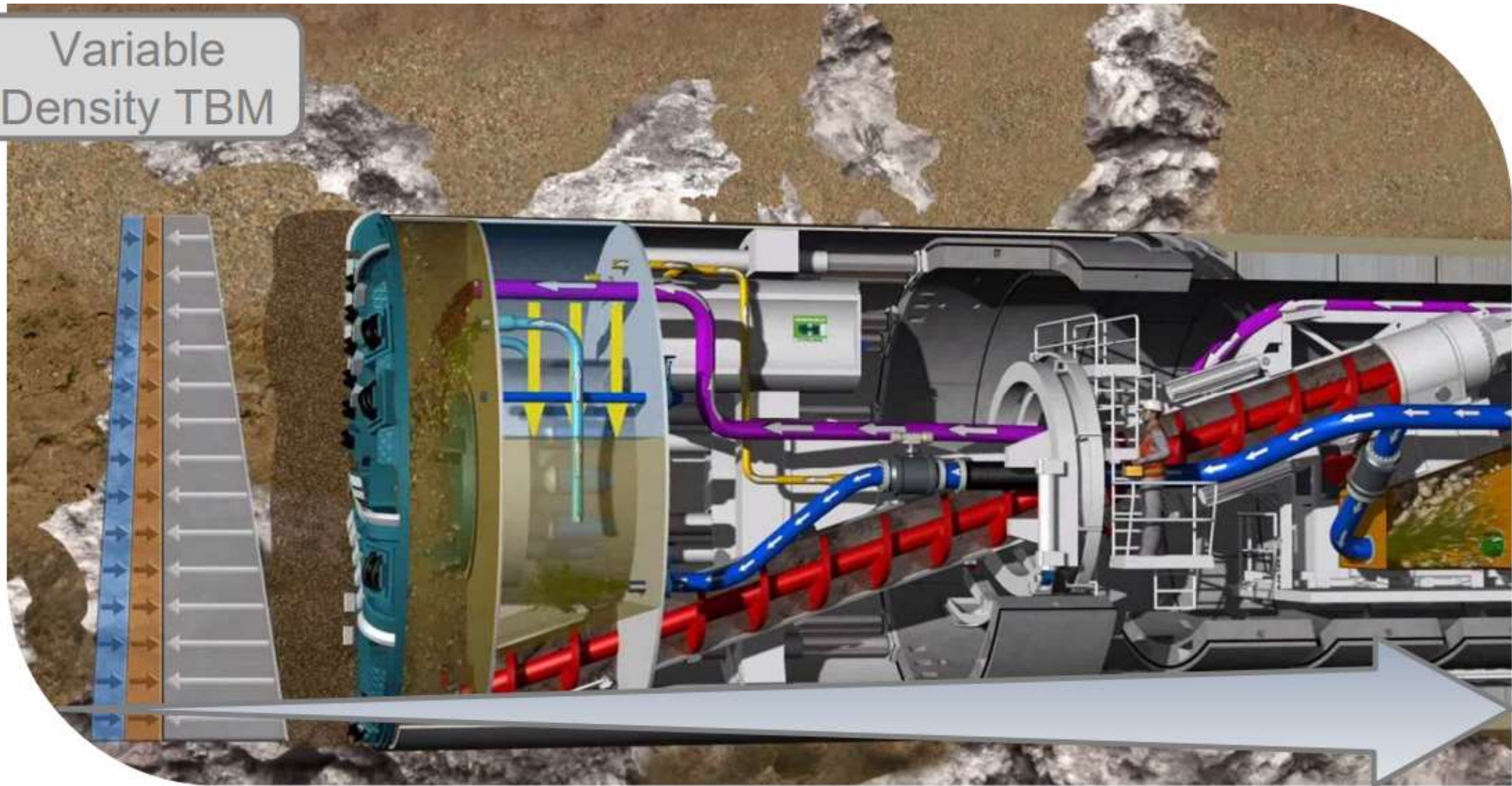

Slurry  
pressure

High density  
slurry or other  
specific slurry

Earth pressure

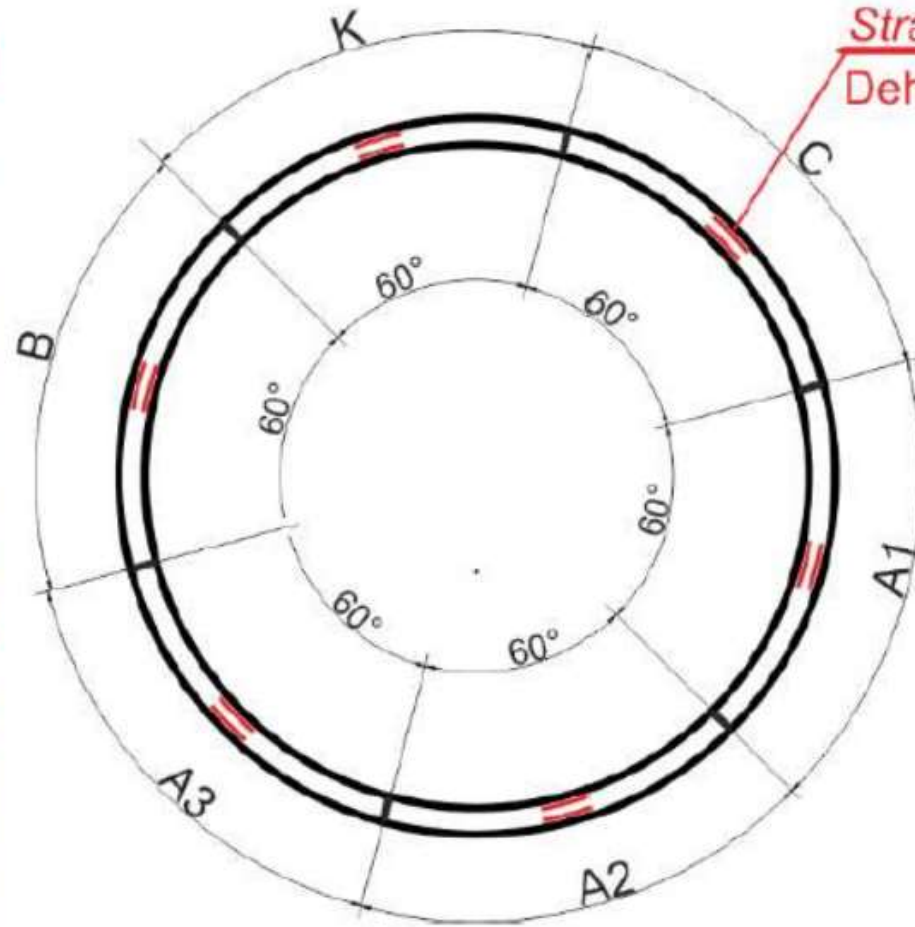

Strain gauge, L~150mm  
Dehnungsgeber, L~150mm

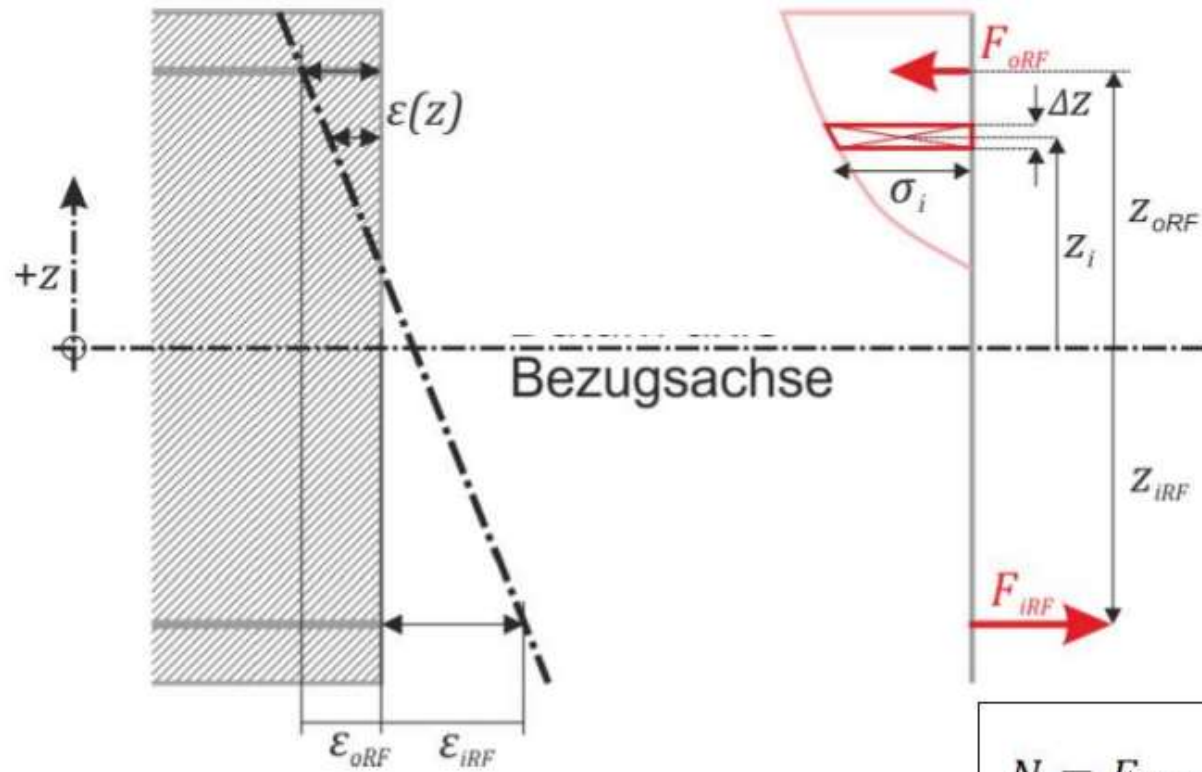

$$\kappa = \frac{\varepsilon_{oRF} - \varepsilon_{iRF}}{z_{oRF} - z_{iRF}}$$

$$\varepsilon_0 = \varepsilon_{iRF} + \kappa z_{iRF}$$

$$\varepsilon(z) = \varepsilon_0 + \kappa z$$

$$N = F_{iRF} + F_{oRF} + b \sum \sigma_i$$

$$M = z_{iRF} F_{iRF} + z_{oRF} F_{oRF} + b \sum \sigma_i z_i$$

## VALIDIERUNG

Reine Biegung

750 kN Normalkraft

Reine Biegung mit doppelter Verbundsteifigkeit

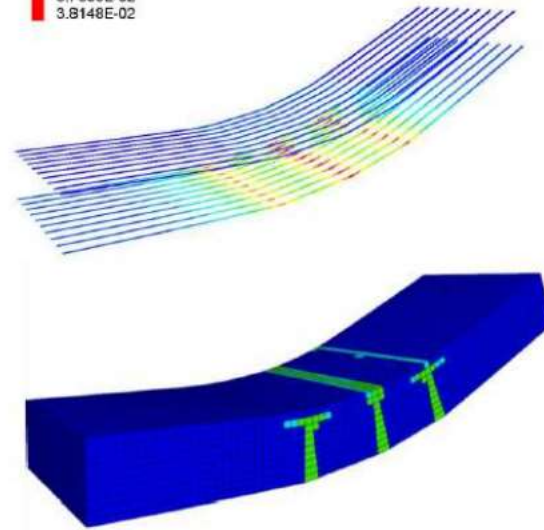
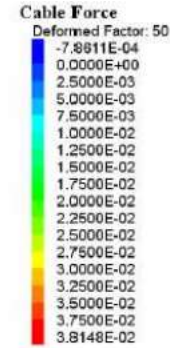
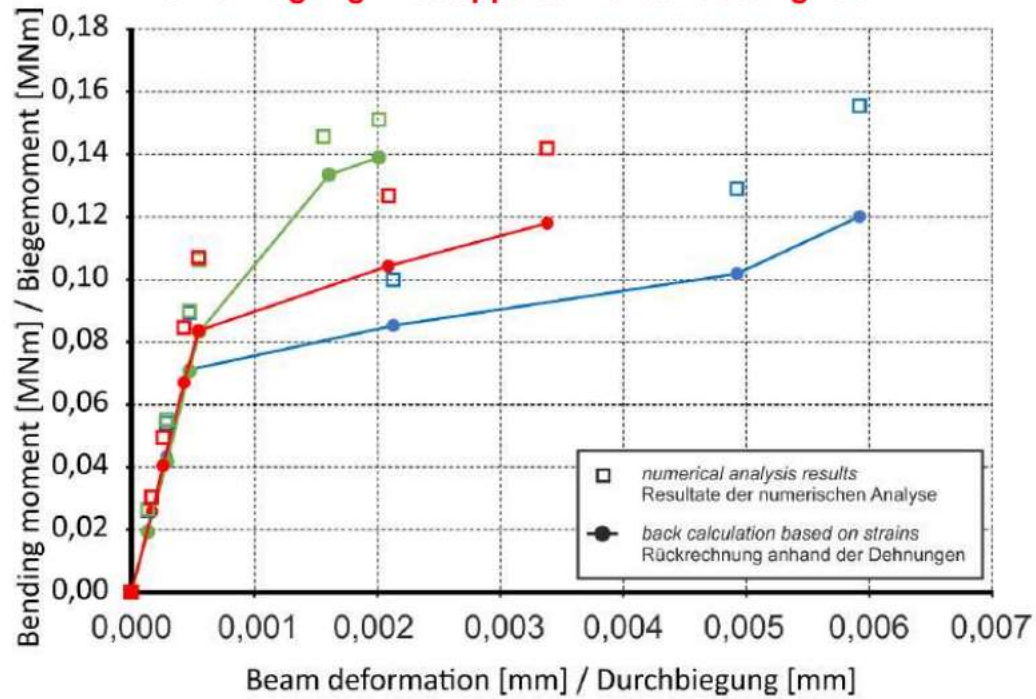

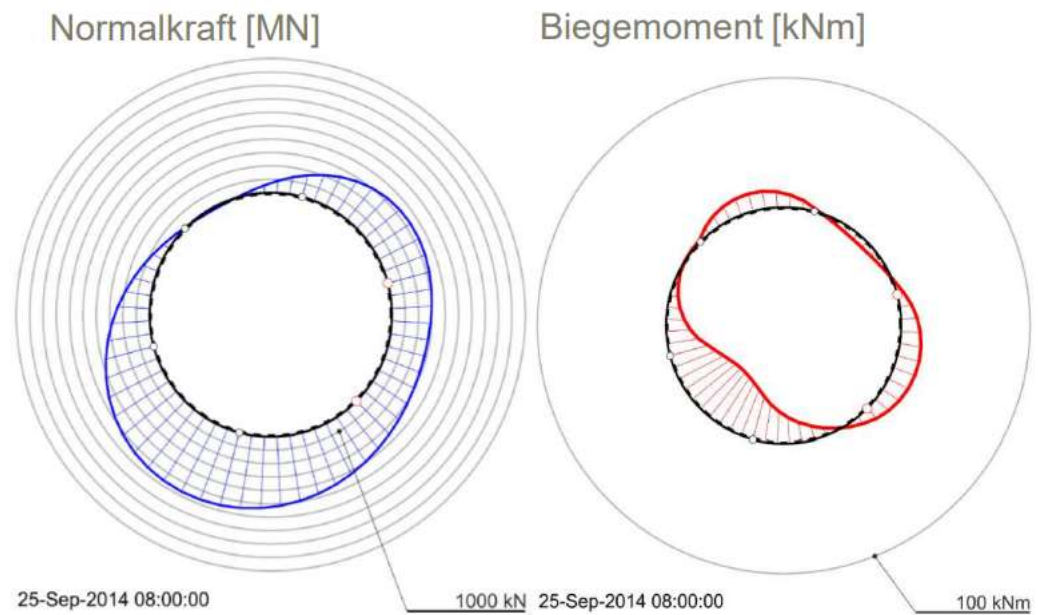
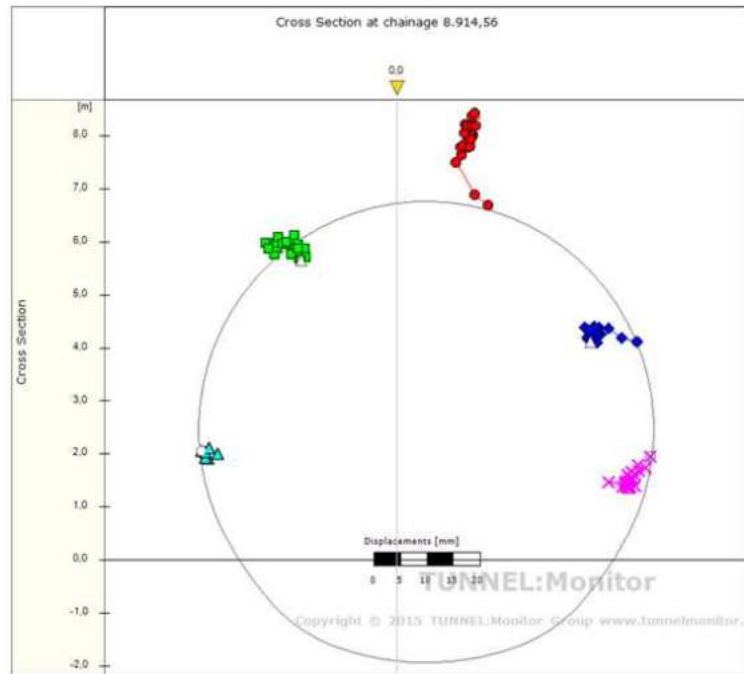



Messtübbing - Ring 4.292 (VM 8.591)  
M-N - Interaktionsdiagramm

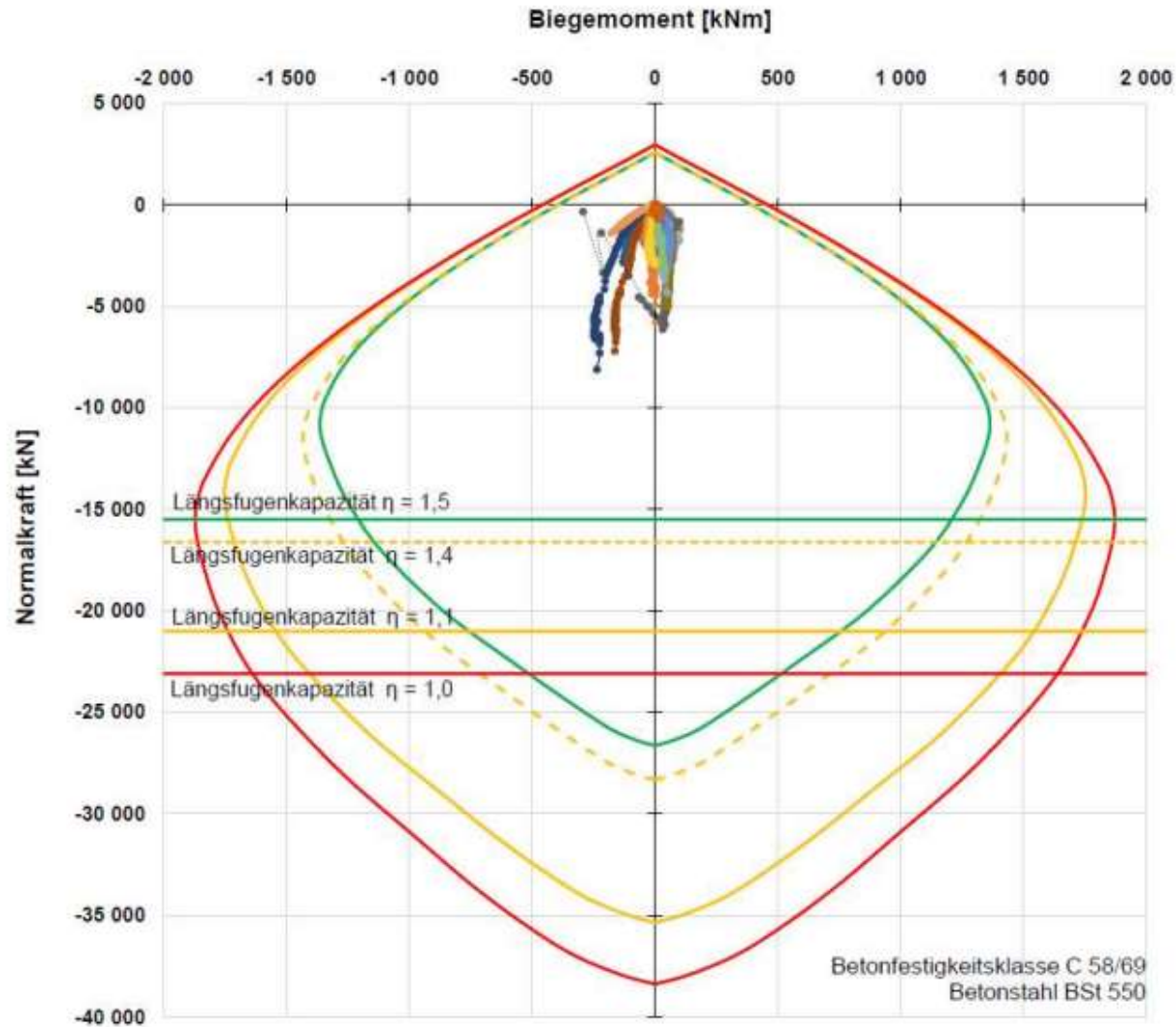

Ringstellung 12

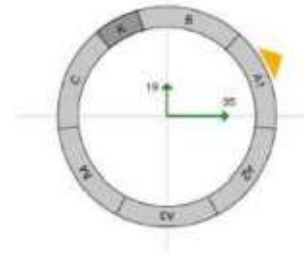

- M-N - Umhüllende, Materialsisicherheit = 1,5
- - - M-N - Umhüllende, Materialsisicherheit = 1,4
- M-N - Umhüllende, Materialsisicherheit = 1,1
- M-N - Umhüllende, Materialsisicherheit = 1,0
- A1 - 1
- A1 - 2
- A1 - 3
- A2 - 1
- A2 - 2
- A2 - 3
- A3 - 1
- A3 - 2
- A3 - 3
- A4 - 1
- A4 - 2
- A4 - 3
- B - 1
- B - 2
- B - 3
- C - 1
- C - 2
- C - 3
- K - 1

## General comment

---

- Large ground movements as a result of fault crossing, landslides and liquefaction hazards constitutes the **greatest risk** to tunnels and underground structures
- In general, it is not easy to design underground structures to withstand large permanent ground displacements. Consequently, a **preferred strategy is to avoid** any potential site susceptible to these hazards
- When it is impossible to avoid fault crossing, crossing landslide zones and liquefaction prone areas, ground **stabilisation** should be undertaken
- If ground stabilisation against fault displacement, seismically triggered landslides or liquefaction is not feasible, the structure should be **designed to accommodate** the longitudinal deformation within acceptable limits

# RION ANTIRRION IMMERSED TUNNEL (GREECE)

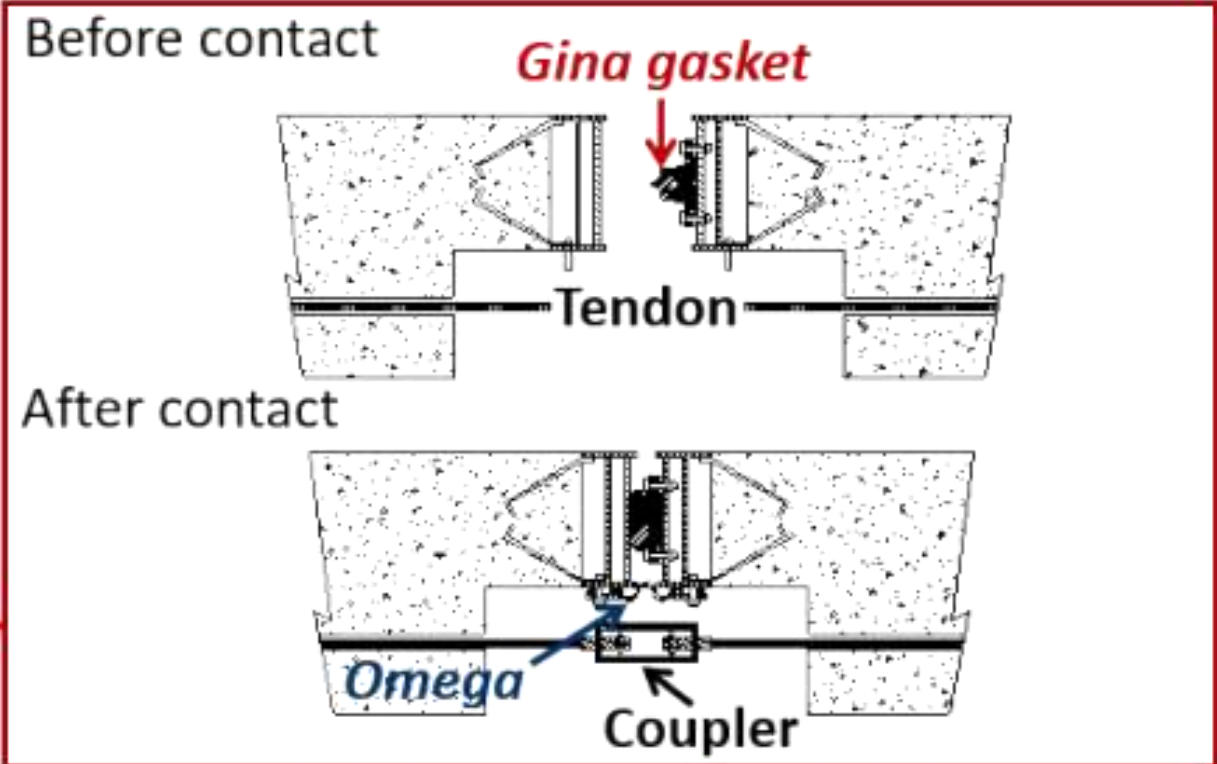
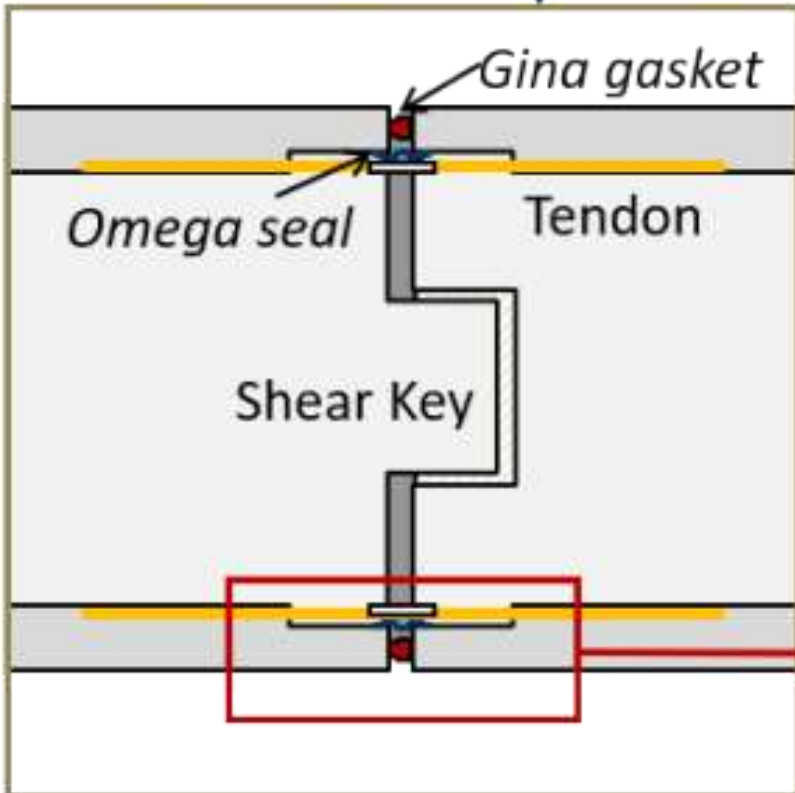
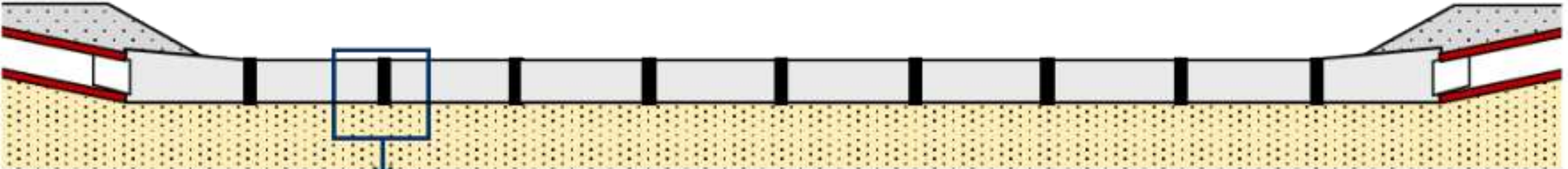

# MOSE VENEZIA FOUR IMMERSED TUNNELS

# **Seismic design against seismically-induced ground failures (fault crossing, slope instabilities, liquefaction)**

## Transient seismic action in longitudinal direction

Imposed ground deformations

1. Simplified approach (Newmark), SSI effects are ignored
2. Beam on soil-spring approach
3. Full dynamic numerical approach of the coupled soil-tunnel system

## Impedance functions proposed in EN 1998-5

---

Simplified relations proposed in the under-revision draft of EN1998-5

- **Transversal direction**

$$K_h = 0.5(G/H_{st})$$

- **Longitudinal direction**

$$K_{h,a} = \frac{16\pi G_s (1-\nu_s) d}{(3-4\nu_s) L}, \quad K_v = \frac{2\pi G_s d}{(1-\nu_s) L}$$

- $K_{h,\alpha}$  and  $K_{v,\alpha}$  : Soil springs in the horizontal and vertical direction respectively
- $G$  : Equivalent shear modulus of the soil compatible to the ground strains amplitudes estimated for the design ground shaking

*Note: the above simplified formulations can lead to soil spring stiffnesses that may deviate considerably from the actual soil stiffness*

## Comments on modeling and seismic design of tunnels against transversal ground shaking (1/2)

---

Issues affecting the seismic response of underground structures and the efficiency of analyses methods

- **Epistemic uncertainties** of simplified analyses methods, i.e. R-F method, equivalent static analysis methods, analytical and numerical solutions
- Effects of **relative stiffness, soil-lining interface** characteristics and soil yielding on the seismic response of tunnels
- Efficiency and accuracy of the available **impedance factors**, i.e. soil springs and dashpots, for tunnels
- Magnitude and distribution of the **dynamic earth-pressures** and soil shear stresses developed along the perimeter of rectangular tunnels
- **Complex deformation** modes of rectangular tunnels during shaking
- Effect of **above ground structures** on the seismic response of tunnels ('city effects')



## Full dynamic time history analysis of the coupled soil-tunnel system

- Numerical methods and tools can efficiently simulate complex geometries, properties and heterogeneities of the soil deposit, as well as complex loading patterns and effects of other existing structures (stations, shafts, above ground structures etc.) on the seismic response of tunnels
- **However they need high level expertise and rigorous knowledge of the software used and its capacities**
- Simulation of longitudinal and transversal seismic response simultaneously; proper selection of design time histories (acceleration, velocity); adequate modeling of the boundary conditions
- **High computational cost** and hence generally adequate only for the final analysis step.

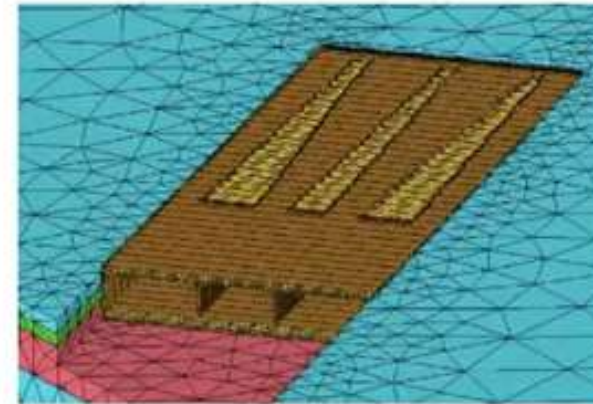
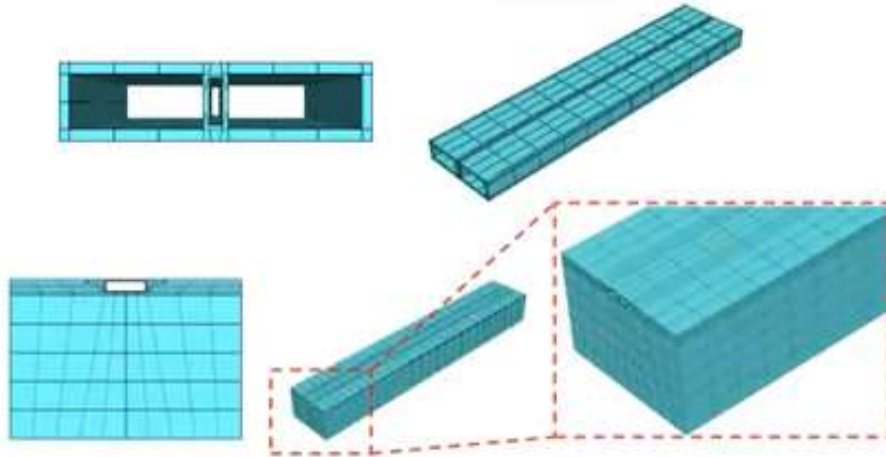

## Physical modelling: shake table testing



## Numerical analysis: validation against shake table tests

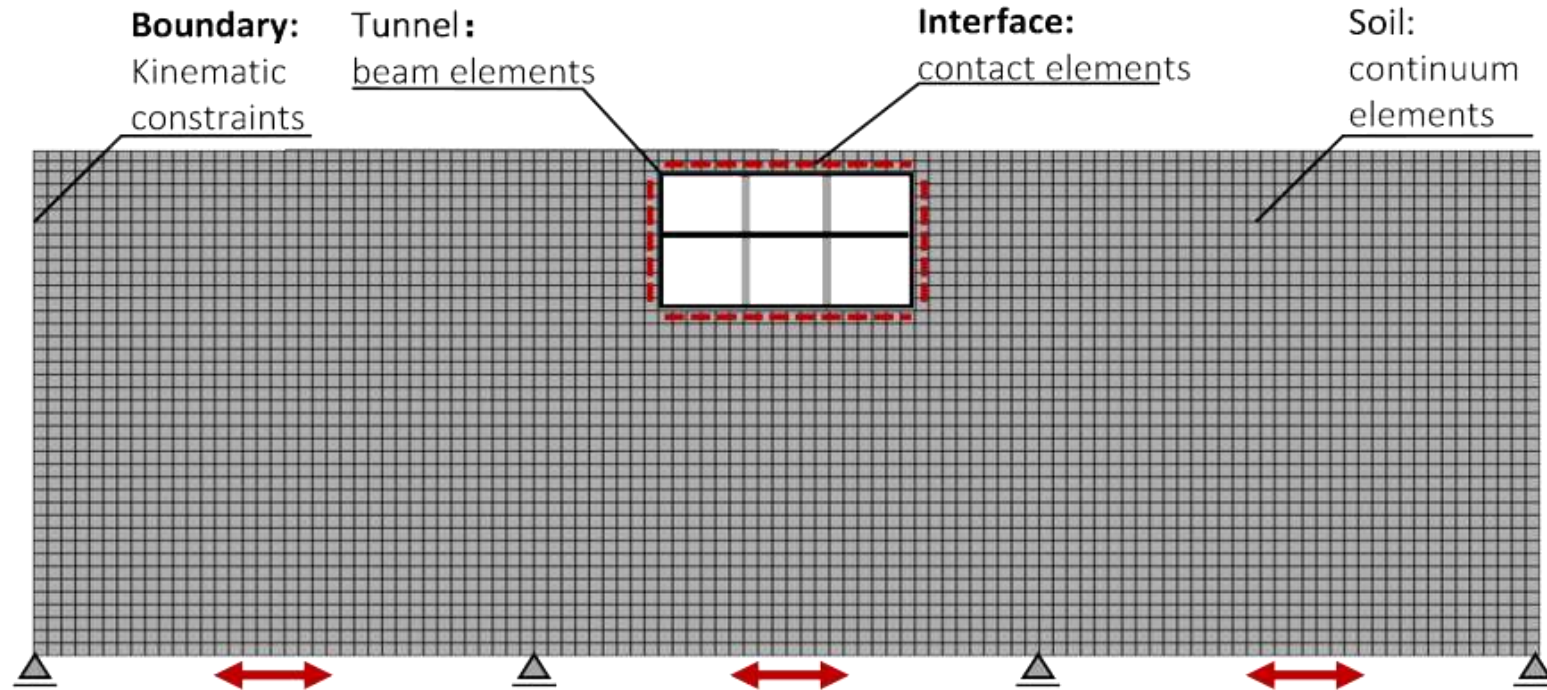

## Full dynamic time history analysis of the coupled soil-tunnel system

- Numerical methods and tools can efficiently simulate complex geometries, properties and heterogeneities of the soil deposit, as well as complex loading patterns and effects of other existing structures (stations, shafts, above ground structures etc.) on the seismic response of tunnels

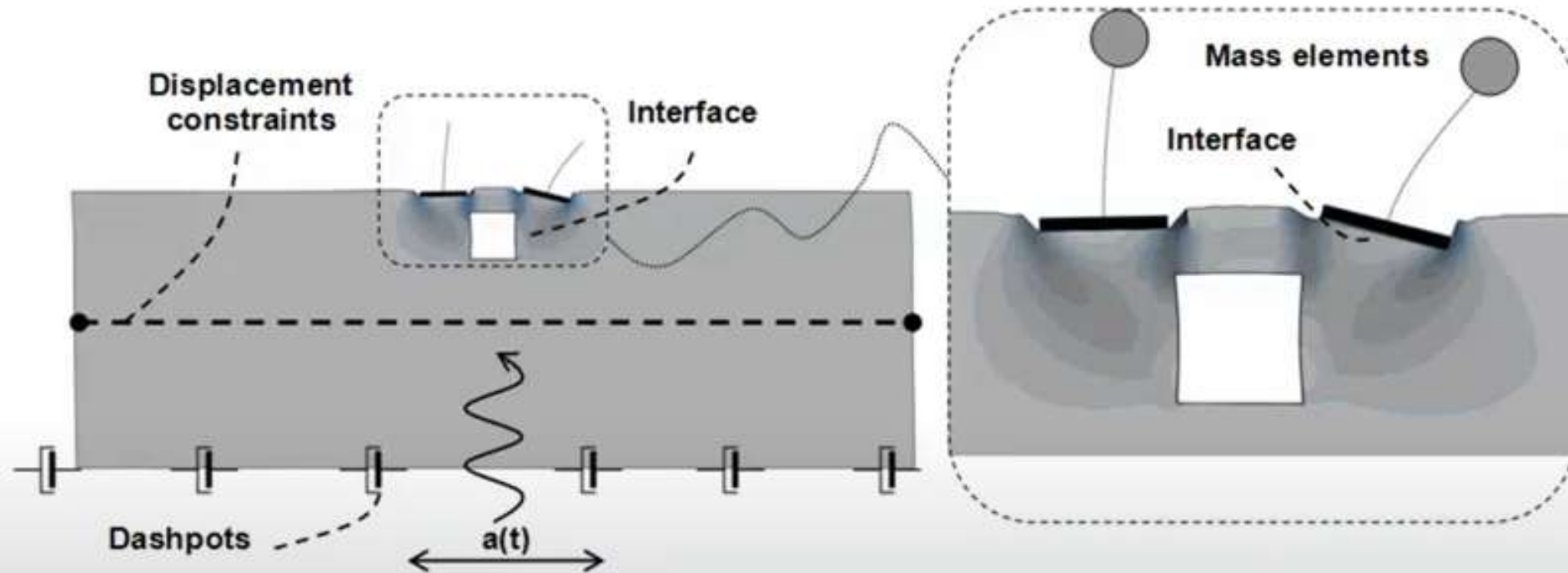

Tsinidis (2015)

# IMMERSED TUNNELS FEHMARN BELT 18 KM IN CONSTRUCTION



naent construction.

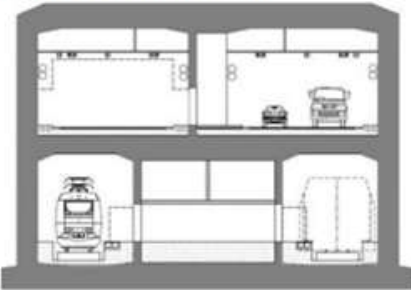

Two level arrangement

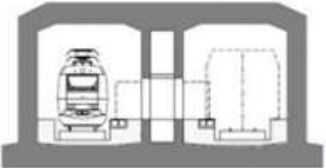



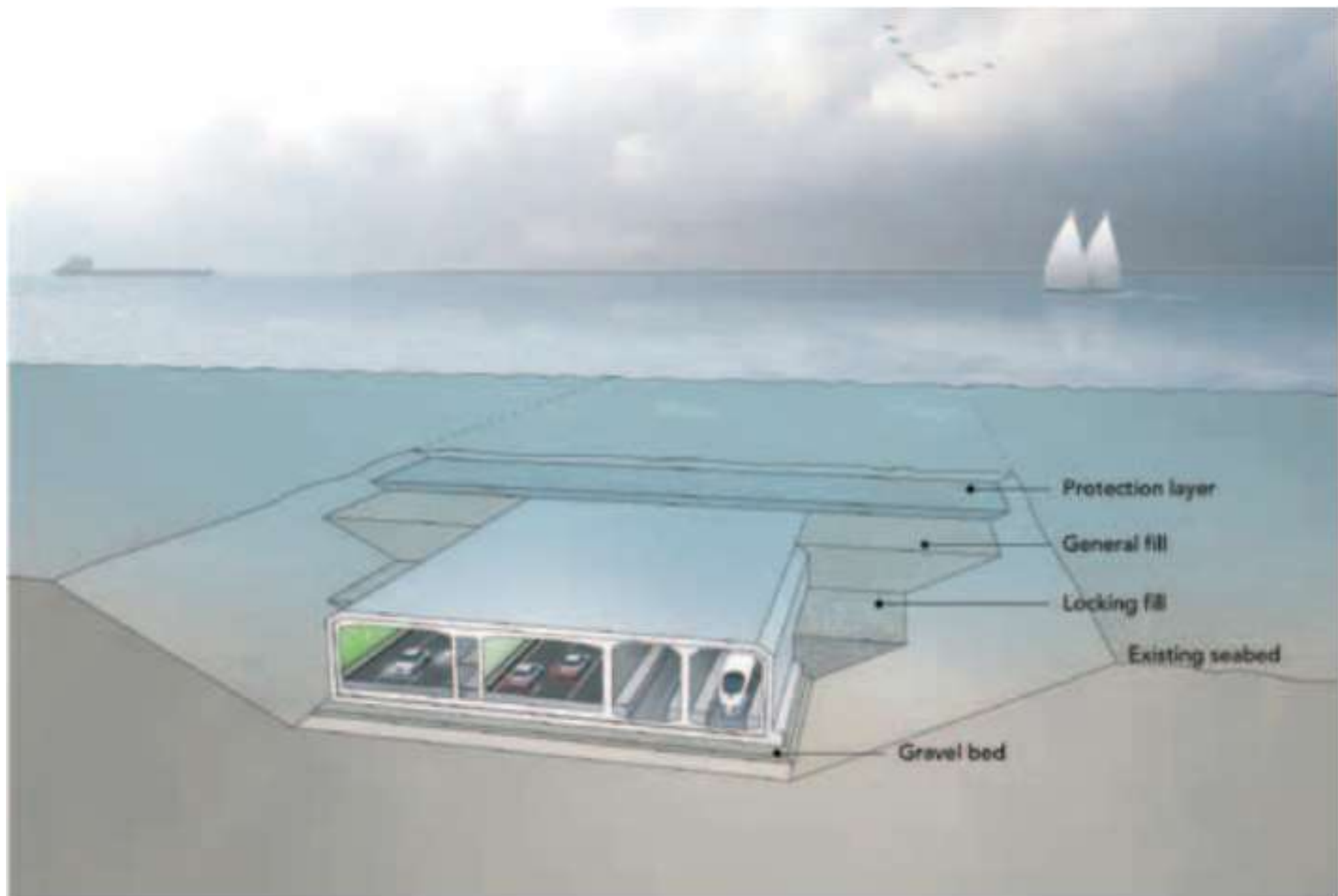
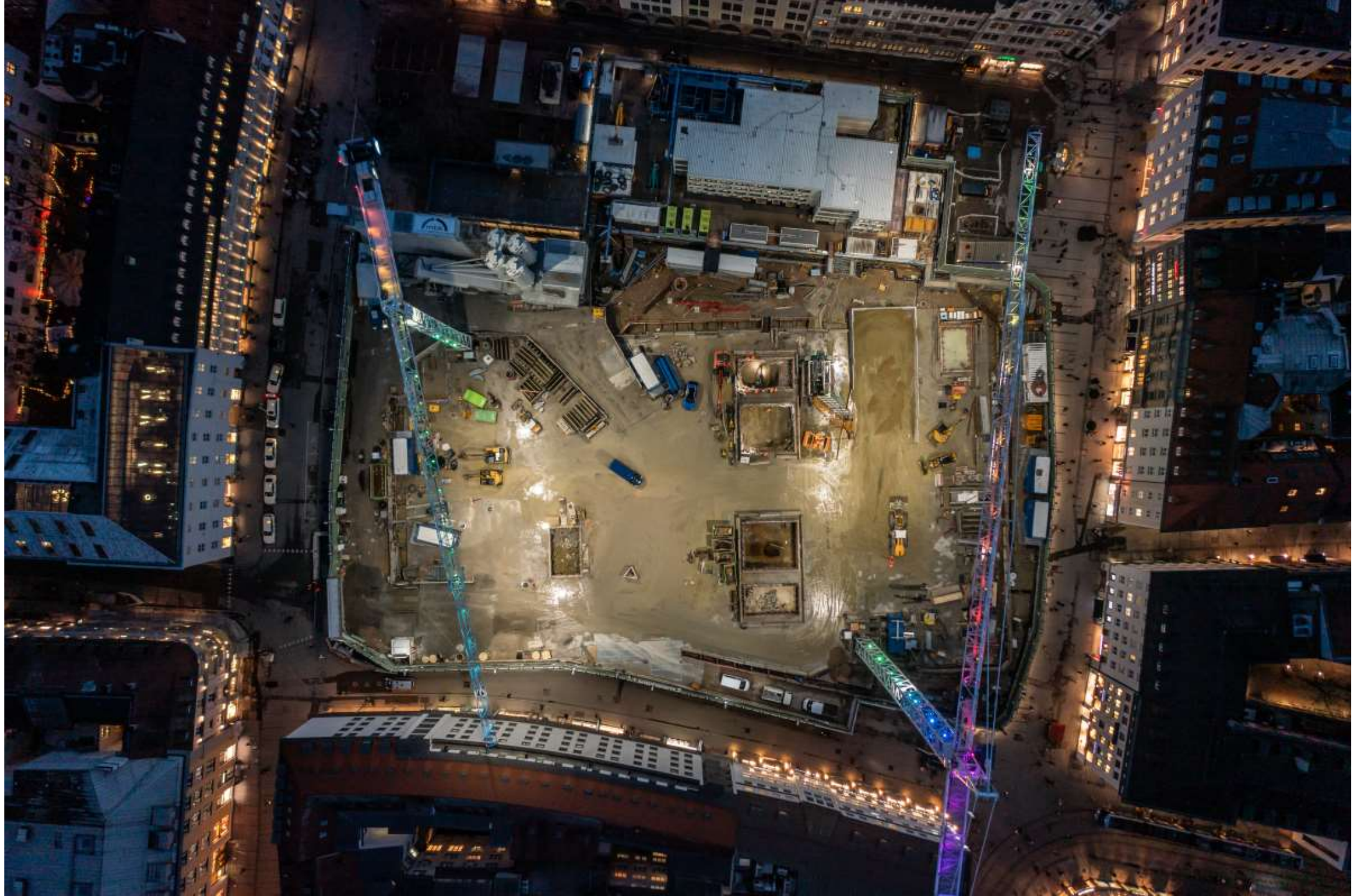
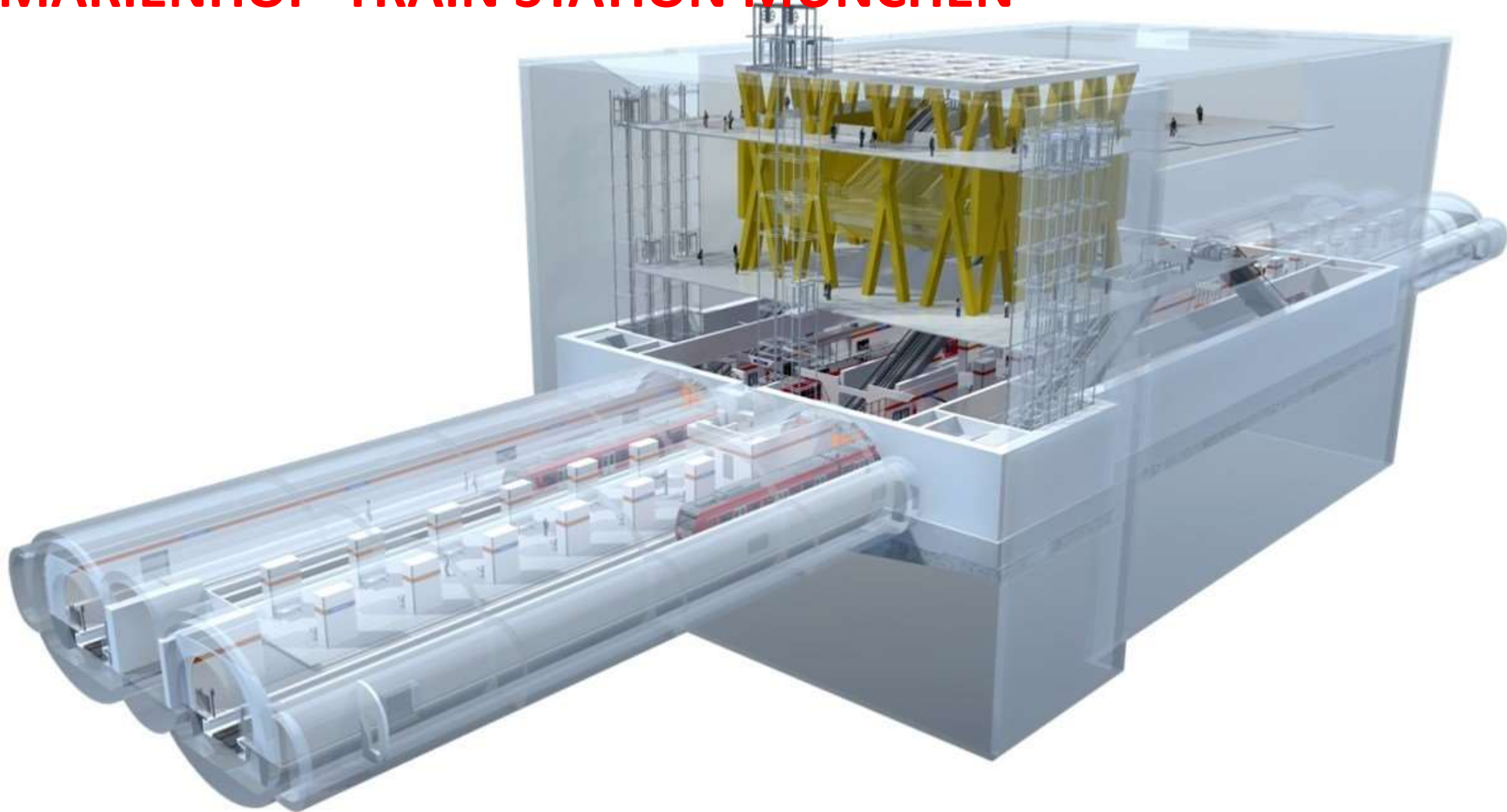

Figure 4. Cross-section of double-ended tank with gravel bed and bed fill.



# MARIENHOF TRAIN STATION MUNCHEN





-50m

Bentonitsuspension

-55m





5:41

AVANTI (SHIFT+N)  
Vom westlichen  
Tunnelportal bis zum

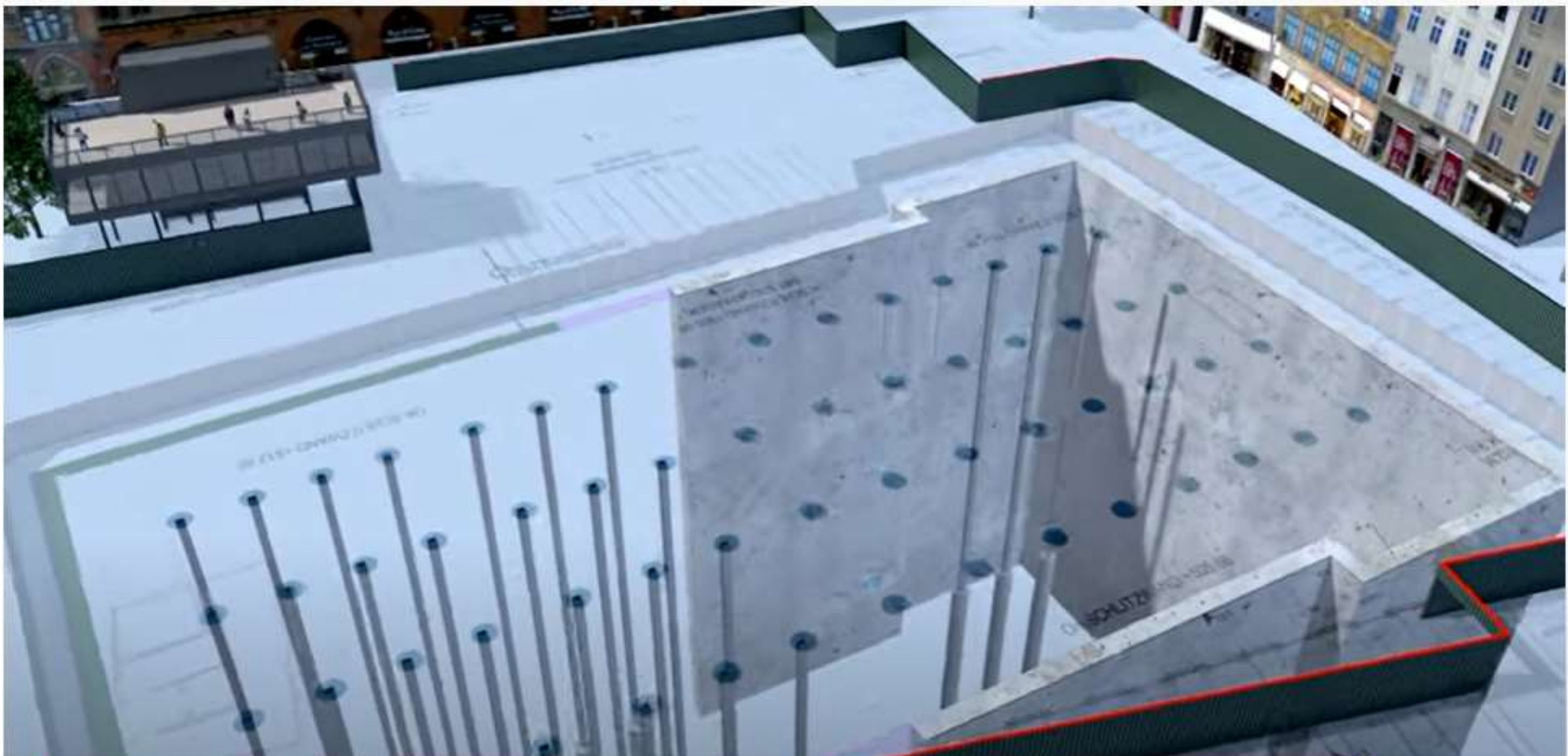

Prinzipdarstellung

2:56 / 3:20



# Collegamento ferroviario con l'Aeroporto di Venezia

## Stazione di Venezia Aeroporto – Piante prospetti e sezioni

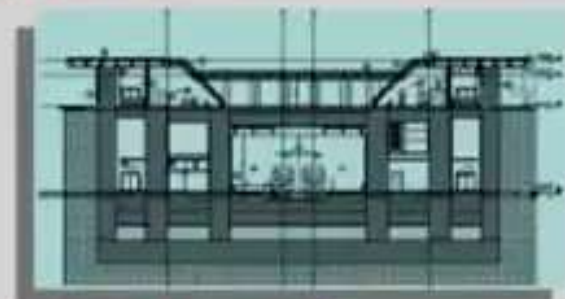
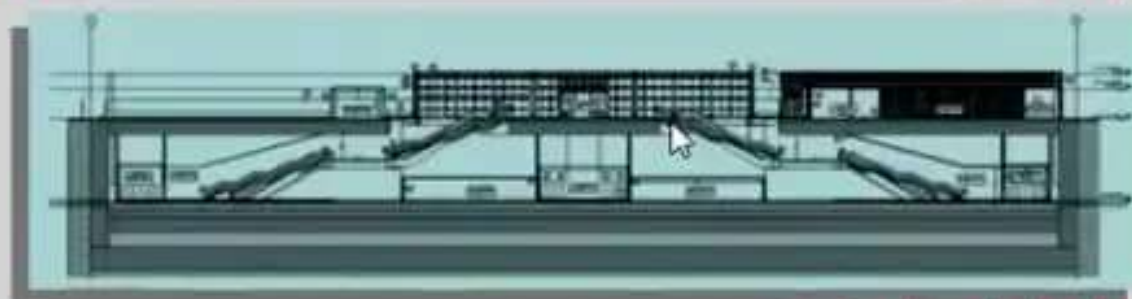
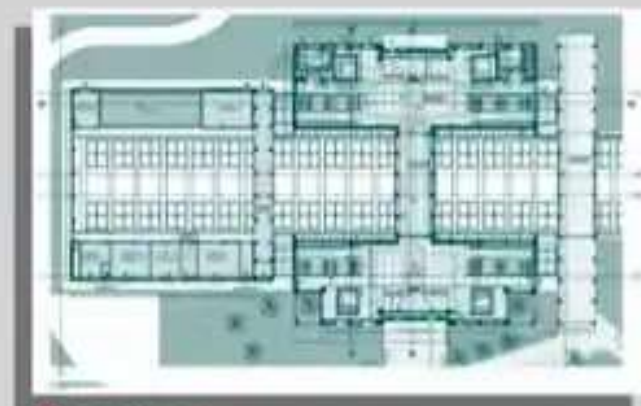
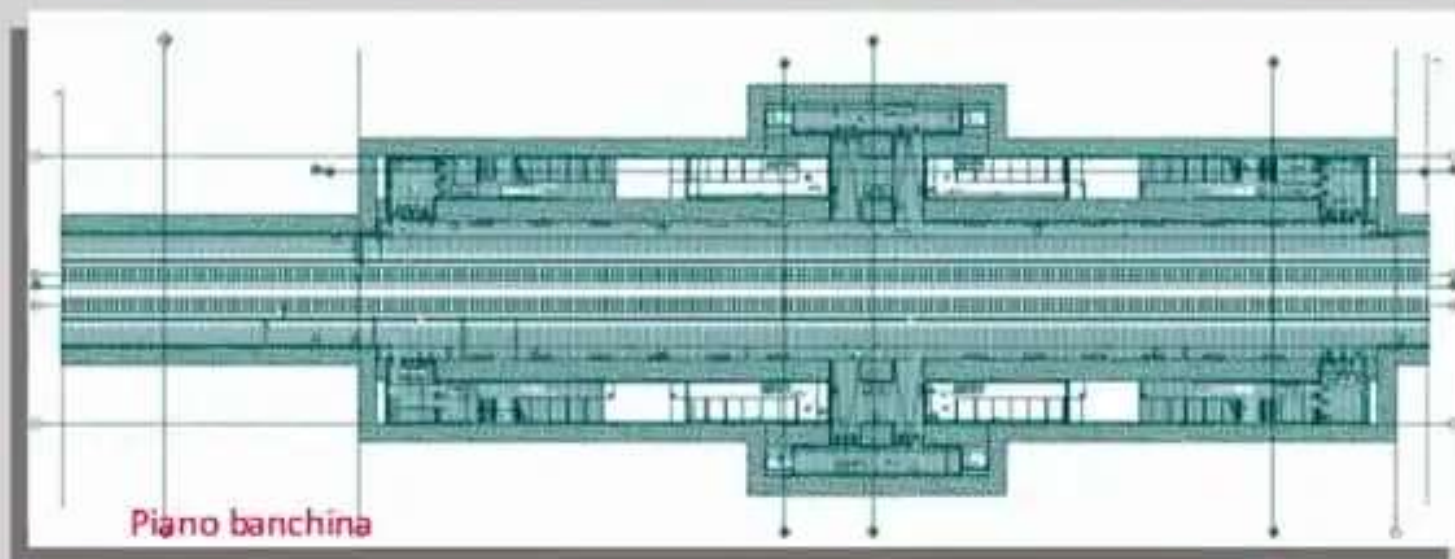





**Figure 1-2: Plan Overview of All Storm Surge Barriers Included Within the NYNJHAT Study Area**